

■ Electrically or pneumatically actuated valves

■ With internal or external pilot air

■ Pneumatic or mechanical reset

Specified types in accordance with ATEX directive for potentially explosive atmospheres

→ www.festo.com/en/ex











Solenoid valves, ISO 5599-1

Product range overview

FESTO

Standard directional control valves
ISO 5599/1

1.2

Function	Version	Type	ISO size	Nominal flow rate [l/min]	Pneumatic working port on sub-base	Operating voltage	
						[V DC]	[V AC]
5/2-way valves, single solenoid	Solenoid valve						
		MN1H	1	1,200	G1/4	24	110, 230
			2	2,300	G3/8		
			3	4,500	G1/2		
		MFH	1	1,200	G1/4	12, 24, 42, 48	24, 42, 48, 110, 230, 240
			2	2,300	G3/8		
			3	4,500	G1/2		
		MDH	4	6,000	G3/4	24	42, 110, 230
	Solenoid valve with central plug M12x1						
		MEBH...-ZSR	1	1,200	G1/4	24	-
			2	2,300	G3/8		
			3	4,500	G1/2		
	Solenoid valve with single plug M12x1, connector pin allocation to VDMA or Desina						
		MDH	1	1,200	G1/4	24	-
			2	2,300	G3/8		
3			4,500	G1/2			
5/2-way valves, double solenoid	Double solenoid valve						
		JMN1H	1	1,200	G1/4	24	110, 230
			2	2,300	G3/8		
			3	4,500	G1/2		
	Double solenoid valve with dominant signal at 14						
		JMN1DH	1	1,200	G1/4	24	110, 230
			2	2,300	G3/8		
			3	4,500	G1/2		
	Double solenoid valve						
		JMFH	1	1,200	G1/4	12, 24, 42, 48	24, 42, 48, 110, 230, 240
			2	2,300	G3/8		
			3	4,500	G1/2		
	Double solenoid valve with dominant signal						
		JMFDH	1	1,200	G1/4	12, 24, 42, 48	24, 42, 48, 110, 230, 240
			2	2,300	G3/8		
3			4,500	G1/2			
Double solenoid valve							
	JMDH	4	6,000	G3/4	24	42, 110, 230	

Solenoid valves, ISO 5599-1

Product range overview

FESTO

Type	Pilot air supply		Type of reset		→ Page
	internal	external	pneumatic spring	mechanical spring	
Solenoid valve					
MN1H	■	■	■	■	2 / 1.2-18
	■	■	■	■	
	■	■	■	■	
MFH	■	■	■	■	2 / 1.2-30
	■	■	■	■	
	■	■	■	■	
MDH	■	-	■	-	2 / 1.2-65
Solenoid valve with central plug M12x1					
MEBH...-ZSR	■	-	■	■	2 / 1.2-41
	■	-	■	■	
	■	-	■	■	
Solenoid valve with single plug M12x1, connector pin allocation to VDMA or Desina					
MDH	■	■	■	■	2 / 1.2-30
	■	-	■	■	
	■	-	■	■	
Double solenoid valve					
JMN1H	■	■	-	-	2 / 1.2-22
	■	■	-	-	
	■	■	-	-	
Double solenoid valve with dominant signal at 14					
JMN1DH	■	■	-	-	2 / 1.2-22
	■	■	-	-	
	■	■	-	-	
Double solenoid valve					
JMFH	■	■	-	-	2 / 1.2-34
	■	■	-	-	
	■	■	-	-	
Double solenoid valve with dominant signal at 14					
JMFDH	■	-	-	-	2 / 1.2-34
	■	-	-	-	
	■	-	-	-	
Double solenoid valve					
JMDH	■	-	-	-	2 / 1.2-68
	■	-	-	-	
	■	-	-	-	

Standard directional control valves
ISO 5599/1

1.2





Solenoid valves, ISO 5599-1





Product range overview

FESTO

Standard directional control valves
ISO 5599/1

1.2

Function	Version	Type	ISO size	Nominal flow rate [l/min]	Pneumatic working port on sub-base	Operating voltage	
						[V DC]	[V AC]
5/2-way valves, double solenoid	Double solenoid valve with central plug M12x1						
		JMEBH	1	1,200	G $\frac{1}{4}$	24 V DC	-
			2	2,300	G $\frac{3}{8}$		
			3	4,500	G $\frac{1}{2}$		
	Double solenoid valve with central plug M12x1, dominant signal at 14						
		JMEBDH	1	1,200	G $\frac{1}{4}$	24 V DC	-
			2	2,300	G $\frac{3}{8}$		
			3	4,500	G $\frac{1}{2}$		
	Double solenoid valve with single plug M12x1, connector pin allocation to VDMA or Desina						
		JMDH	1	1,200	G $\frac{1}{4}$	24 V DC	-
			2	2,300	G $\frac{3}{8}$		
			3	4,500	G $\frac{1}{2}$		
	Double solenoid valve with single plug M12x1, connector pin allocation to VDMA or Desina, dominant signal at 14						
		JMDDH	1	1,200	G $\frac{1}{4}$	24 V DC	-
			2	2,300	G $\frac{3}{8}$		
			3	4,000	G $\frac{1}{2}$		

Function	Version	Type	ISO size	Nominal flow rate [l/min]	Pneumatic working port on sub-base	Operating voltage	
						[V DC]	[V AC]
5/3-way valves	Solenoid valve						
		MN1H-5/3...	1	1,200	G $\frac{1}{4}$	24	110, 230
			2	2,300	G $\frac{3}{8}$		
			3	4,100	G $\frac{1}{2}$		
		MFH-5/3...	1	1,200	G $\frac{1}{4}$	12, 24, 42, 48	24, 42, 48, 110, 230, 240
			2	2,300	G $\frac{3}{8}$		
			3	4,100	G $\frac{1}{2}$		
		MDH-5/3...	4	6,000	G $\frac{3}{4}$	24	110, 230
	Solenoid valve with central plug M12x1						
		MEBH-5/3-...-ZSR	1	1,200	G $\frac{1}{4}$	24	-
			2	2,300	G $\frac{3}{8}$		
			3	4,100	G $\frac{1}{2}$		
	Solenoid valve with single plug M12x1, connector pin allocation to VDMA or Desina						
		MDH-5/3...	1	1,200	G $\frac{1}{4}$	24	-
			2	2,300	G $\frac{3}{8}$		
3			4,000 ...4,600	G $\frac{1}{2}$			

Solenoid valves, ISO 5599-1

Product range overview

FESTO

Type	Pilot air supply		Type of reset		→ Page
	internal	external	pneumatic spring	mechanical spring	
Double solenoid valve with central plug M12x1					
JMEBH	■	-	-	-	2 / 1.2-45
	■	-	-	-	
	■	-	-	-	
Double solenoid valve with central plug M12x1, with dominant signal					
JMEBDH	■	-	-	-	2 / 1.2-45
	■	-	-	-	
	■	-	-	-	
Double solenoid valve with single plug M12x1, connector pin allocation to VDMA or Desina					
JMDH	■	-	-	-	2 / 1.2-34
	■	-	-	-	
	■	-	-	-	
Double solenoid valve with single plug M12x1, connector pin allocation to VDMA or Desina, dominant signal at 14					
JMDDH	■	-	-	-	2 / 1.2-34
	■	-	-	-	
	■	-	-	-	

Type	Pilot air supply		Mid position			→ Page
	internal	external	closed	exhausting	pressurised	
Solenoid valve						
MN1H-5/3...	■	■	■	■	■	2 / 1.2-26
	■	■	■	■	■	
	■	■	■	■	■	
MFH-5/3...	■	■	■	■	■	2 / 1.2-37
	■	■	■	■	■	
	■	■	■	■	■	
MDH-5/3...	■	-	■	■	-	2 / 1.2-71
Solenoid valve with central plug M12x1						
MEBH-5/3-...-ZSR	■	-	■	■	■	2 / 1.2-49
	■	-	■	■	■	
	■	-	■	■	■	
Solenoid valve with single plug M12x1, connector pin allocation to VDMA or Desina						
MDH-5/3...	■	-	■	■	■	2 / 1.2-37
	■	-	■	■	■	
	■	-	■	■	■	

Standard directional control valves
ISO 5599/1

1.2



Pneumatic valves, ISO 5599-1

Product range overview

FESTO

Standard directional control valves
ISO 5599/1

1.2

Function	Version	Type	ISO size	Nominal flow rate [l/min]	Pneumatic working port on sub-base	Type of reset		→ Page
						pneumatic spring	mechanical spring	
5/2-way valves	Pneumatic valve, single pilot							
		VL	1	1,200	G $\frac{1}{4}$	■	■	2 / 1.2-78
			2	2,300	G $\frac{3}{8}$	■	■	
			3	4,500	G $\frac{1}{2}$	■	■	
			4	6,000	G $\frac{3}{4}$	■	■	
	Pneumatic double pilot valve							
		J	1	1,200	G $\frac{1}{4}$	-	-	2 / 1.2-82
			2	2,300	G $\frac{3}{8}$	-	-	
			3	4,500	G $\frac{1}{2}$	-	-	
			4	6,000	G $\frac{3}{4}$	-	-	
	Pneumatic double pilot valve with dominant signal at 14							
		JD	1	1,200	G $\frac{1}{4}$	-	-	2 / 1.2-82
2			2,300	G $\frac{3}{8}$	-	-		
3			4,500	G $\frac{1}{2}$	-	-		

Function	Version	Type	ISO size	Nominal flow rate [l/min]	Pneumatic working port on sub-base	Mid position			→ Page
						closed	exhausted	pressurised	
5/3-way valves	Pneumatic valve								
	VL5/3...	1	1,200	G $\frac{1}{4}$	■	■	■	2 / 1.2-85	
		2	2,300	G $\frac{3}{8}$	■	■	■		
		3	4,100	G $\frac{1}{2}$	■	■	■		
		4	4,800	G $\frac{3}{4}$	■	■	■		

Solenoid valves, ISO 5599-1

Type codes for valves with square plug

MN1H		5/3	G	D-1				C	
Type									
MN1H	Single pilot, for N1 solenoid coil								
MFH	Single solenoid, for F solenoid coil								
MDH	Single solenoid, with D solenoid coil								
MEBH	Single solenoid, with EB solenoid coil								
JMN1H	Double solenoid, for N1 solenoid coil								
JMN1DH	Double solenoid, for N1 solenoid coil, with dominant signal at 14								
JMFH	Double solenoid, for F solenoid coil								
JMFDH	Double solenoid, for F solenoid coil, with dominant signal at 14								
JMDH	Double solenoid, with D solenoid coil								
Valve function									
5/2	5/2-way valve								
5/3	5/3-way valve								
Mid position									
G	closed								
E	exhausted								
B	pressurised								
Size									
D-1	ISO size 1								
D-2	ISO size 2								
D-3	ISO size 3								
¾-D-4	ISO size 4								
Electrical connection, operating voltage									
Plug, square design to DIN EN 175301-803, type A									
24DC	24 V DC								
Pilot air supply									
	internal								
S	external								
Type of reset									
FR	Mechanical spring								
	Pneumatic spring								
Generation									
C	Series C								
Material									
CT	Free of copper and PTFE								

Solenoid valves, ISO 5599-1

Type codes for valves with round plug



Standard directional control valves
ISO 5599/1
1.2

		MDH	-	5/3	G	-	D-1	-		-		-		-	C	-	
Type																	
MDH	Single solenoid, with D solenoid coil																
MEBH	Single solenoid, with EB solenoid coil																
JMDH	Double solenoid, for D solenoid coil																
JMDDH	Double solenoid, for D solenoid coil, with dominant signal at 14																
JMEBH	Double solenoid, with EB solenoid coil																
JMEBDH	Double solenoid, with EB solenoid coil, with dominant signal at 14																
Valve function																	
5/2	5/2-way valve																
5/3	5/3-way valve																
Mid position																	
G	closed																
E	exhausted																
B	pressurised																
Size																	
D-1	ISO size 1																
D-2	ISO size 2																
D-3	ISO size 3																
Electrical connection, operating voltage																	
Central plug, round design, M12x1																	
ZSR	24 V DC																
Individual plug, round design, M12x1																	
M12	24 V DC																
Pin allocation																	
	2-pin to VDMA																
D	4-pin to Desina																
Pilot air supply																	
	internal																
S	external																
Type of reset																	
FR	Mechanical spring Pneumatic spring																
Generation																	
C	Series C																

Solenoid valves, ISO 5599-1

Peripherals overview



Port pattern on sub-base to ISO 5599-1

Defined interfaces between valve and sub-base

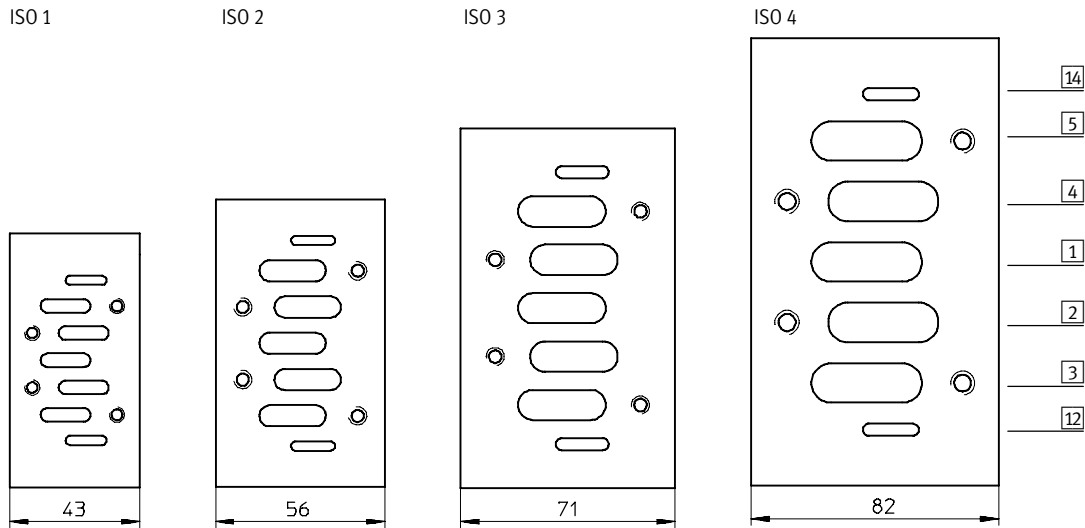

Standard directional control valves
ISO 5599/1

1.2

Sub-base port designations		
	Solenoid valves	Pneumatic valves
14	Control section	External pilot air supply for pilot valve 14
5	Power section	Valve exhaust port 5
4	Power section	Working port 4 www.festo.com
1	Power section	Working air supply port 1
2	Power section	Working port 2
3	Power section	Valve exhaust port 3
12	Control section	External pilot air supply for pilot valve 12
		Signal input 12

Solenoid valves, ISO 5599-1

Peripherals overview



Standard directional control valves
ISO 5599/1

1.2

Individual mounting with square plug

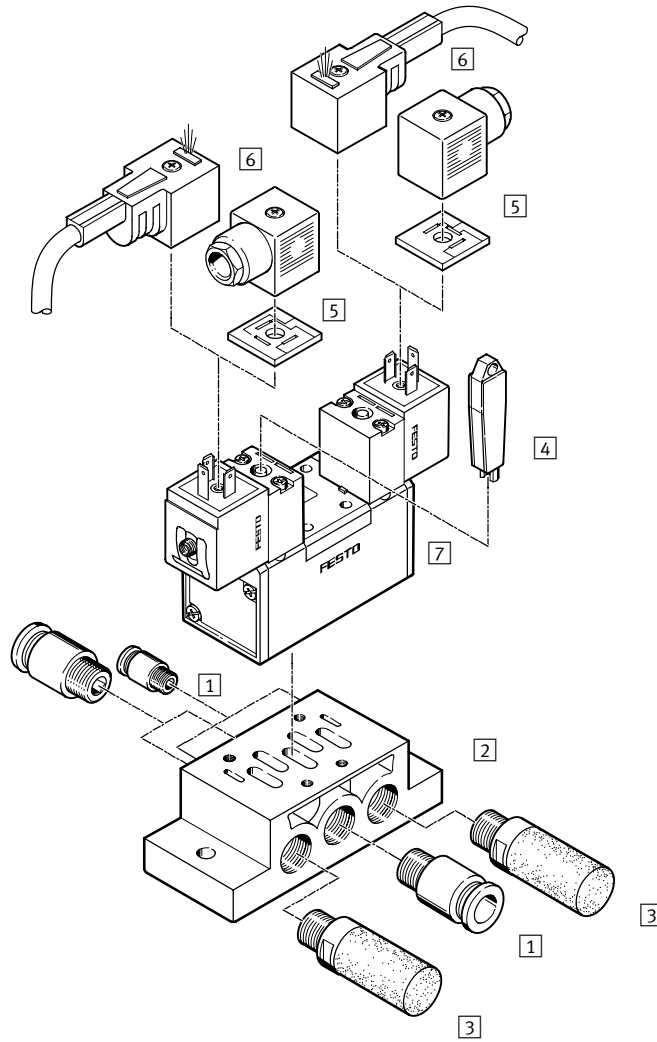

Variants

MN1H-5/2

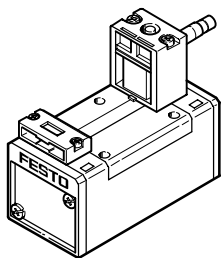

MFH-5/2

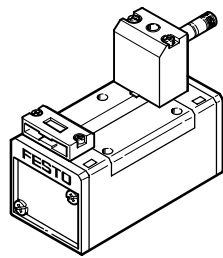

MDH-5/2-D-4

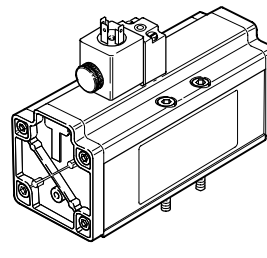

JMN1H-5/2, MN1H-5/3

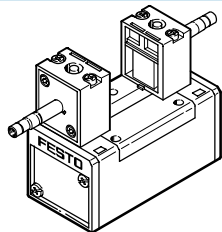

JMFH-5/2, MFH-5/3

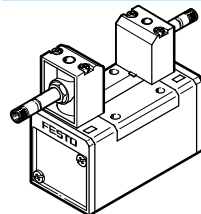

JMDH-5/2-D-4, MDH-5/3-D-4

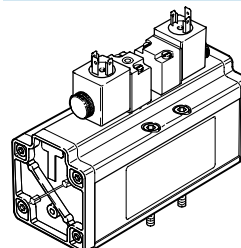

Solenoid valves, ISO 5599-1

Peripherals overview

FESTO

Accessories		
	Brief description	→ Page
1	Push-in fitting QS	For connecting compressed air tubing with standard O.D. to CETOP RP 54 P Volume 3 www.festo.com
2	Individual sub-base NAS	With lateral ports 2 / 1.2-88
3	Silencers	For fitting in exhaust ports Volume 3 www.festo.com
4	Manual override tool AHB	2 / 1.2-99
5	Illuminating seal M...-LD	For indicating the switching status 2 / 1.2-102
6	Plug sockets with/without cables MSSD, KMF, KMC	2 / 1.2-101
7	Solenoid valve	Port pattern to ISO 5599-1, corresponding solenoid coils → 2 / 1.2-100 2 / 1.2-2

Standard directional control valves
ISO 5599/1

1.2

Solenoid valves, ISO 5599-1

Peripherals overview

FESTO

Standard directional control valves
ISO 5599/1

1.2

Individual mounting with round plug

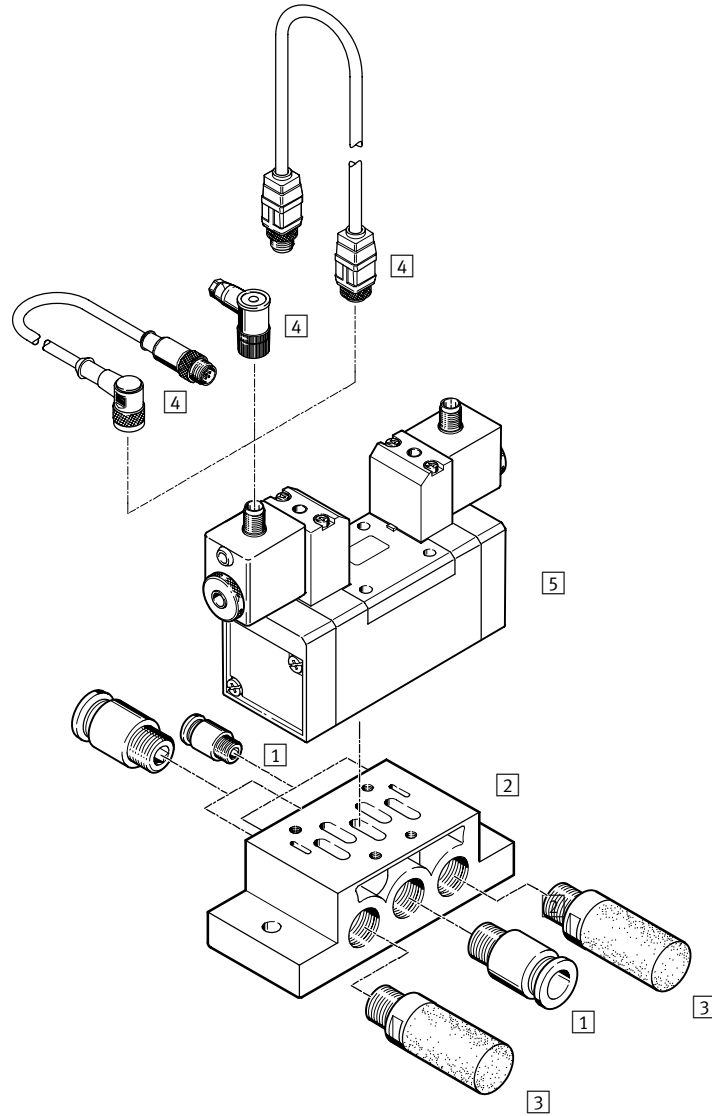

Variants

MDH-5/2

JMDH-5/2, MDH-5/3

MEBH-5/2

JMEBH-5/2, MEBH-5/3

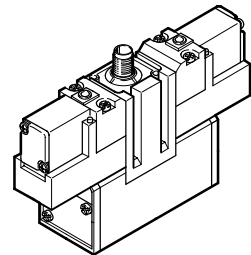
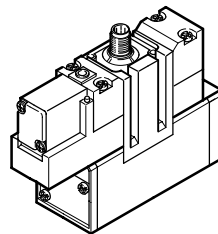
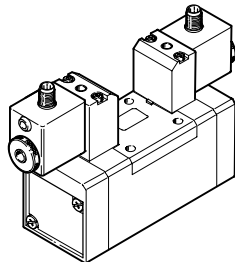
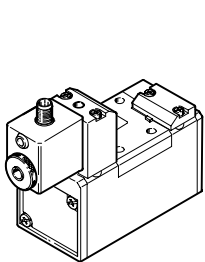

Solenoid valves, ISO 5599-1

Peripherals overview

FESTO

Accessories		
	Brief description	→ Page
1	Push-in fitting QS	For connecting compressed air tubing with standard O.D. to CETOP RP 54 P Volume 3 www.festo.com
2	Individual sub-base NAS	With lateral ports 2 / 1.2-88
3	Silencers	For fitting in exhaust ports Volume 3 www.festo.com
4	Plug sockets with/without cables SAE, KM	2 / 1.2-102
5	Solenoid valve	Port pattern to ISO 5599-1 2 / 1.2-41

Standard directional control valves
ISO 5599/1

1.2

Solenoid valves, ISO 5599-1

Peripherals overview

FESTO

Standard directional control valves
ISO 5599/1
1.2

Manifold mounting with square plug

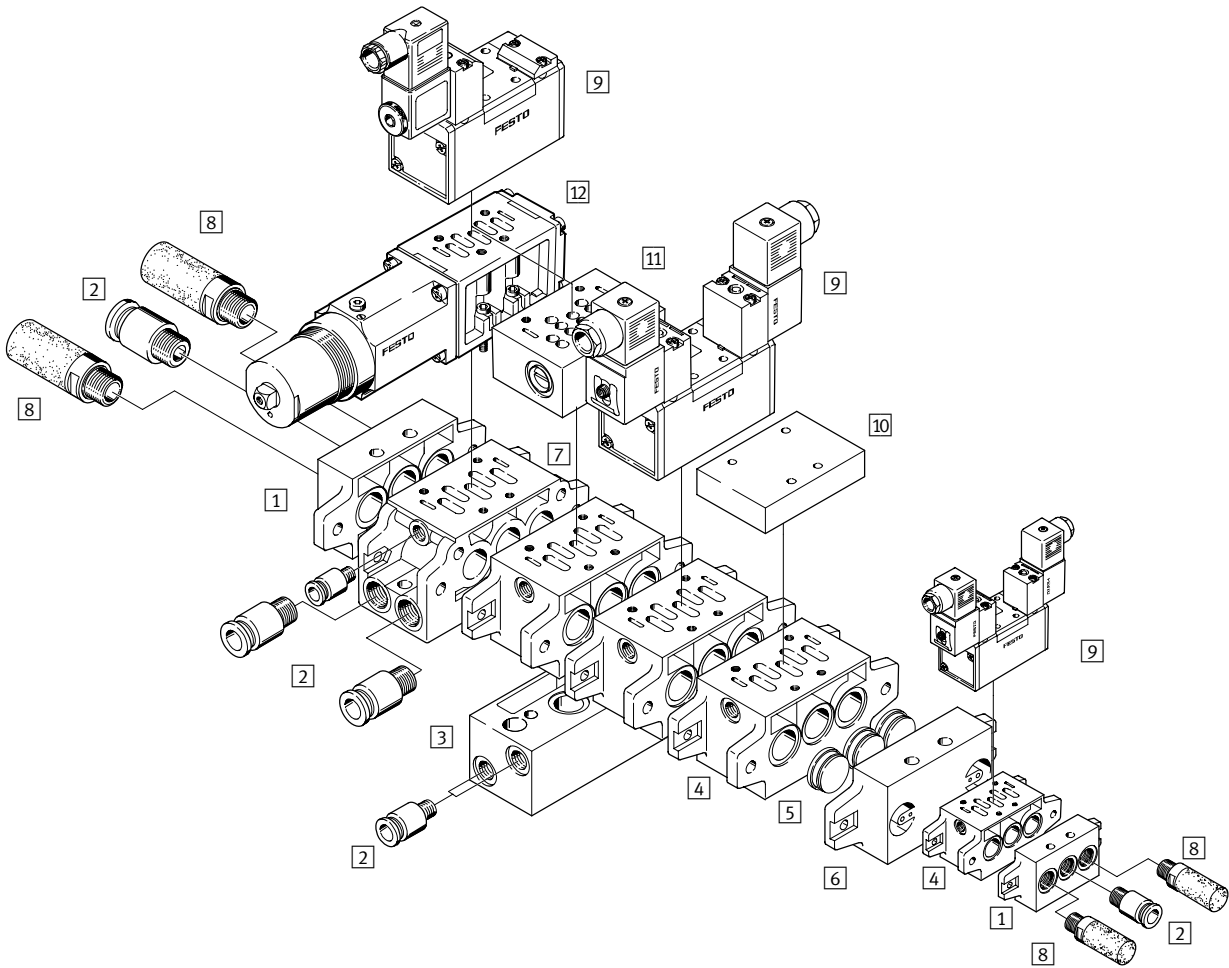

Variants

MN1H-5/2

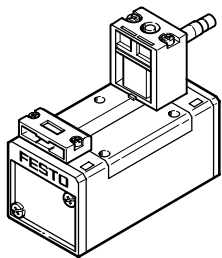

MFH-5/2

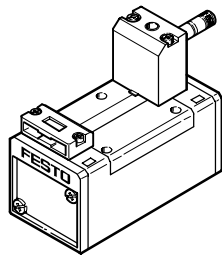

MDH-5/2-D-4

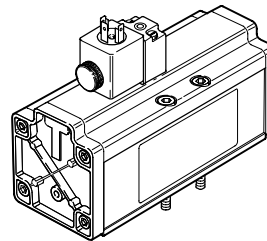

JMN1H-5/2, MN1H-5/3

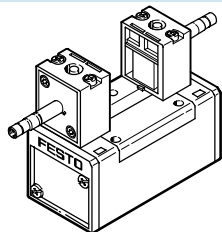

JMFH-5/2, MFH-5/3

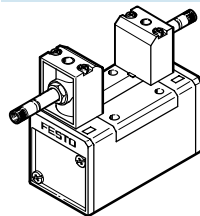

JMDH-5/2-D-4, MDH-5/3-D-4

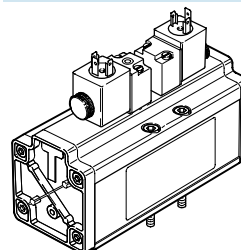

Solenoid valves, ISO 5599-1

FESTO

Peripherals overview

Accessories		
	Remarks	→ Page
1 End plate kit NEV	For sealing the manifold sub-bases	2 / 1.2-91
2 Push-in fitting QS	For connecting compressed air tubing with standard O.D. to CETOP RP 54 P	Volume 3 www.festo.com
3 Angle connection block NAW	For routing ports 2 and 4 to the front	2 / 1.2-90
4 Manifold sub-base NAV	With ports 2 and 4 underneath	2 / 1.2-90
5 Isolating disc NSC	For sealing the common lines 1, 3, 5 between end plates and manifold sub-bases or between 2 manifold sub-bases, e.g. for different working pressures	2 / 1.2-92
6 Intermediate plate NZV	For connecting manifold sub-bases of different sizes	2 / 1.2-94
7 Manifold sub-base for angle connection NAWW	With ports 2 and 4 either underneath or to the front	2 / 1.2-91
8 Silencers	For fitting in exhaust ports	Volume 3 www.festo.com
9 Solenoid valve	Port pattern to ISO 5599-1, corresponding solenoid coils → 2 / 1.2-100	2 / 1.2-2
10 Blanking plate NDV	For sealing unused manifold sub-bases	2 / 1.2-92
11 Throttle plate GRO	For ISO size 1, 2 and 3 with integrated exhaust air restrictors at ports 3 and 5. The throttle plate is mounted between the valve and the individual sub-base/manifold sub-base	2 / 1.2-95
12 Intermediate pressure regulator plate LR-ZP	For ISO size 1, 2 and 3 for regulating the pressure from 0 to 10 bar according to the supply pressure. The intermediate pressure regulator plate is mounted between the valve and the individual sub-base/manifold sub-base	2 / 1.2-96

Standard directional control valves
ISO 5599/1

1.2

Solenoid valves, ISO 5599-1

Peripherals overview



Standard directional control valves
ISO 5599/1

1.2

Manifold mounting with round plugs

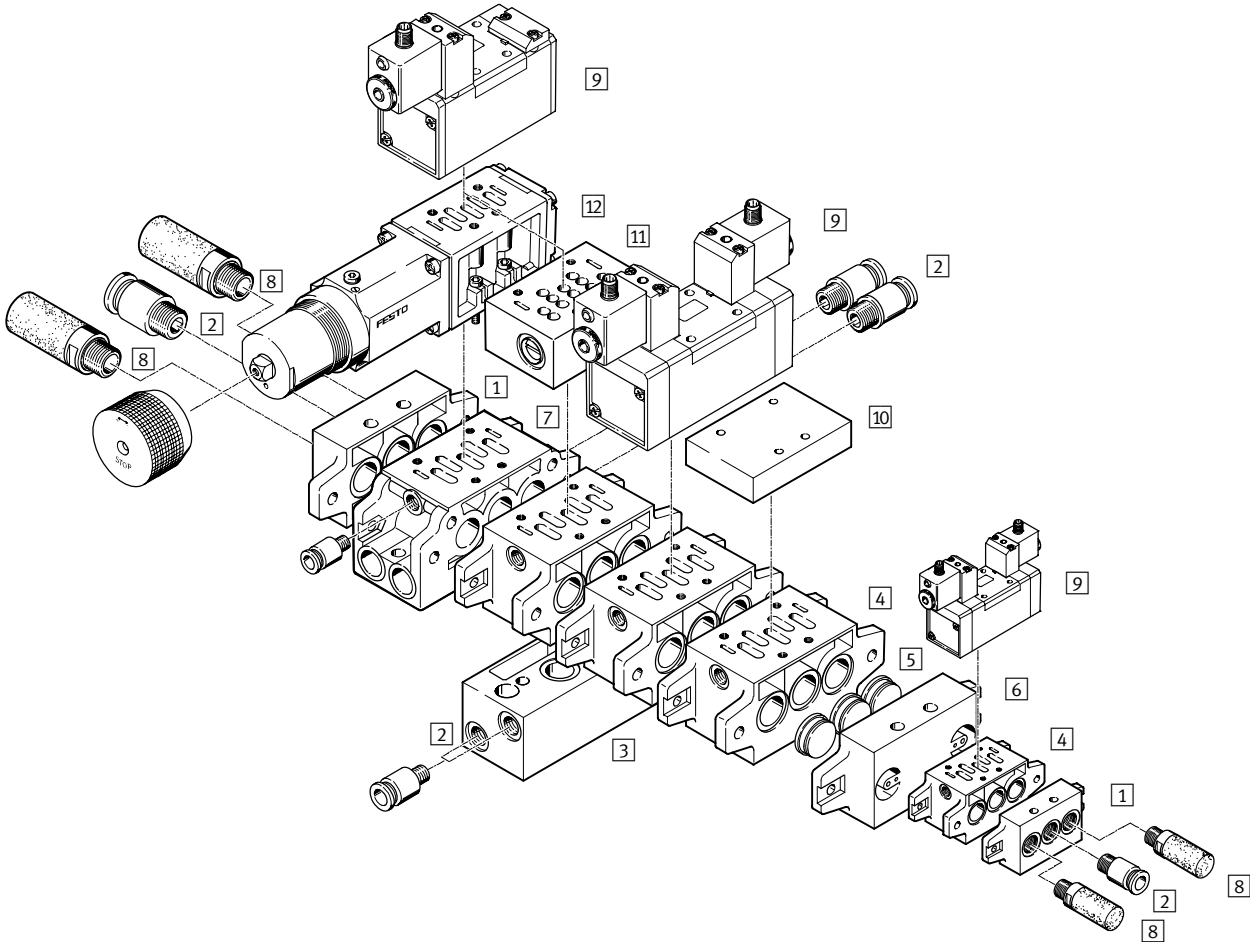

Variants

MDH-5/2

JMDH-5/2, MDH-5/3

MEBH-5/2

JMEBH-5/2, MEBH-5/3

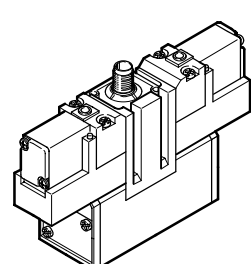
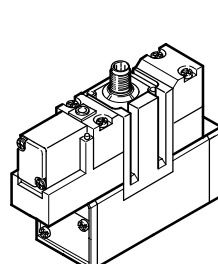
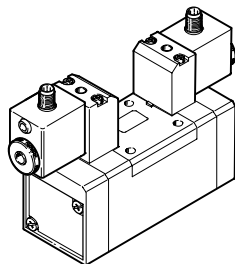
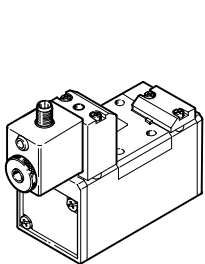

Solenoid valves, ISO 5599-1



Peripherals overview

Accessories		
	Remarks	→ Page
1	End plate kit NEV	For sealing the manifold sub-bases 2 / 1.2-91
2	Push-in fitting QS	For connecting compressed air tubing with standard O.D. to CETOP RP 54 P Volume 3 www.festo.com
3	Angle connection block NAW	For routing ports 2 and 4 to the front 2 / 1.2-90
4	Manifold sub-base NAV	With ports 2 and 4 underneath 2 / 1.2-90
5	Isolating disc NSC	For sealing the common lines 1, 3, 5 between end plates and manifold sub-bases or between 2 manifold sub-bases, e.g. for different working pressures 2 / 1.2-92
6	Intermediate plate NZV	For connecting manifold sub-bases of different sizes 2 / 1.2-94
7	Manifold sub-base for angle connection NAWW	With ports 2 and 4 either underneath or to the front 2 / 1.2-91
8	Silencers	For fitting in exhaust ports Volume 3 www.festo.com
9	Solenoid valve	Port pattern to ISO 5599-1 2 / 1.2-2
10	Blanking plate NDV	For sealing unused manifold sub-bases 2 / 1.2-92
11	Throttle plate GRO	For ISO size 1, 2 and 3 with integrated exhaust air restrictors at ports 3 and 5. The throttle plate is mounted between the valve and the individual sub-base/manifold sub-base 2 / 1.2-95
12	Intermediate pressure regulator plate LR-ZP	For ISO size 1, 2 and 3 for regulating the pressure from 0 to 10 bar according to the supply pressure. The intermediate pressure regulator plate is mounted between the valve and the individual sub-base/manifold sub-base 2 / 1.2-96

Solenoid valves MN1H, ISO 5599-1

FESTO

Technical data – 5/2-way valves

-  - Flow rate
1200 ... 4500 l/min
-  - Voltage
24 V DC
110, 230 V AC



Standard directional control valves
ISO 5599/1
1.2

General technical data				
ISO size	1	2	3	
Valve function	5/2-way, single solenoid			
Constructional design	Piston spool			
Sealing principle	Soft			
Actuation type	Electrical			
Type of reset	Mechanical or pneumatic spring			
Type of pilot control	Piloted			
Pilot air supply	Internal or external			
Direction of flow	Non-reversible			
Exhaust function	With flow control			
Manual override	Via accessory, detenting			
Type of mounting	Via through-holes			
Mounting position	Any			
Nominal size	[mm]	8	11	14.5
Standard nominal flow rate	[l/min]	1200	2300	4500
Grid dimension	[mm]	43	56	71
Pneumatic connection on sub-base		G $\frac{3}{4}$	G $\frac{3}{8}$	G $\frac{1}{2}$
Product weight	[g]	450	710	1000
Noise level	[dB (A)]	85		

Operating and environmental conditions			
Type of reset		Pneumatic	Mechanical
Operating medium		Filtered compressed air, lubricated or unlubricated Vacuum	
Operating pressure	Internal pilot air supply [bar]	2 ... 10	3 ... 10
	External pilot air supply [bar]	-0.9 ... +16	-0.9 ... +16
Pilot pressure	[bar]	2 ... 10	3 ... 10
Ambient temperature	[°C]	-10 ... +50	
Temperature of medium	[°C]	-10 ... +50	

Valve response times [ms]						
ISO size	1		2		3	
	Pneumatic	Mechanical	Pneumatic	Mechanical	Pneumatic	Mechanical
On	23	17	46	24	49	33
Off	32	39	69	62	71	74

Solenoid valves MN1H, ISO 5599-1

Technical data – 5/2-way valves

Electrical data			
N1 solenoid coil			
Electrical connection			Plug, square design to EN 175301-803, type A
Operating voltage	D.C. voltage	[V DC]	24
	A.C. voltage	[V AC]	110/230 (50 ... 60 Hz)
Coil characteristics	D.C. voltage	[W]	2.5
	A.C. voltage	[VA]	Pull: 7.5 Hold: 5
Protection class to EN 60 529			IP65

Materials

Sectional view

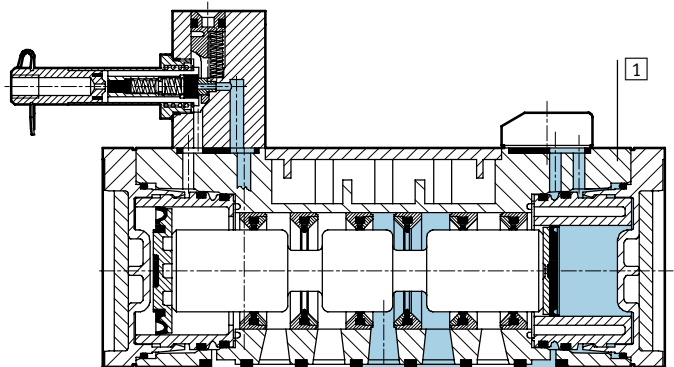

1	Housing	Die-cast aluminium, polyacetate
-	Seals	Nitrile rubber
	Note on material	Versions free of copper, PTFE and silicone → Ordering data

Solenoid valves MN1H, ISO 5599-1

Technical data – 5/2-way valves



Standard directional control valves
ISO 5599/1
1.2

Dimensions

Download CAD data → www.festo.com/en/engineering

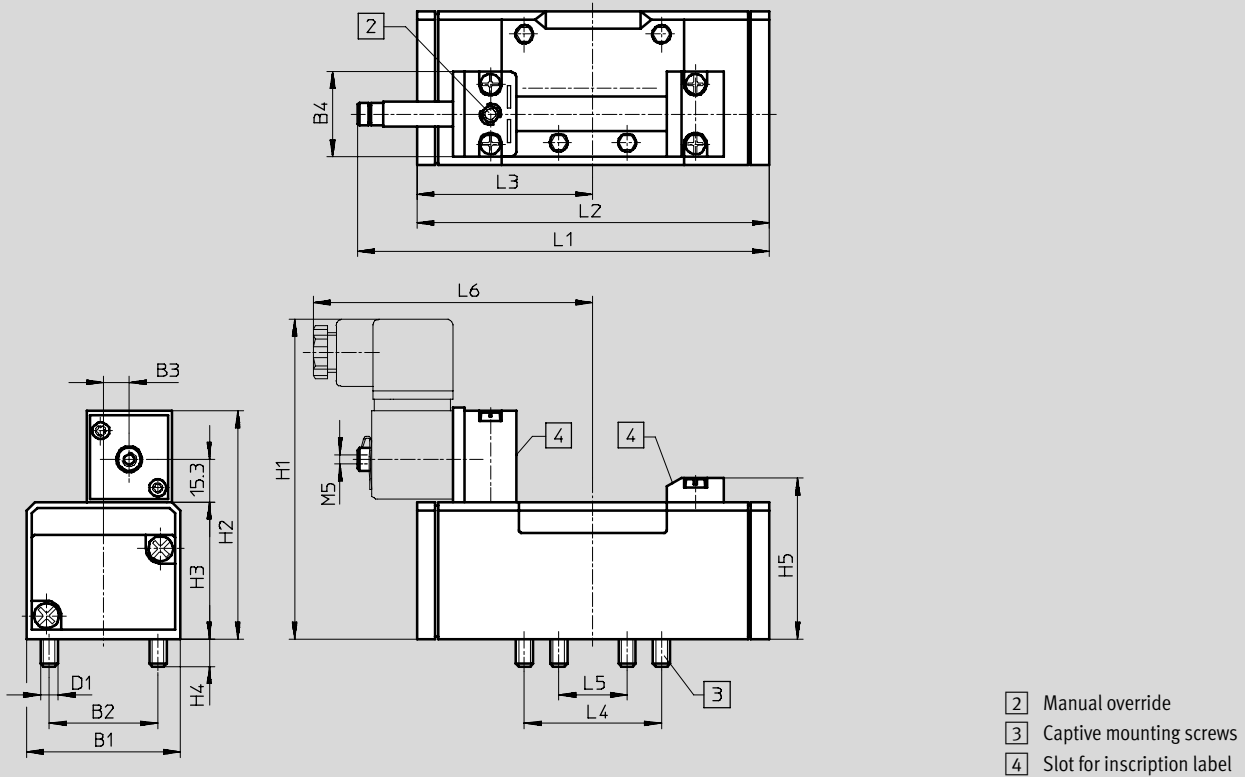

Type	B1	B2	B3	B4	D1	H1	H2	H3	H4	H5	L1	L2	L3	L4	L5	L6
ISO size 1																
MN1H-5/2-...	42	28	6	30	M5	106	74	38	9	46.5	117.5	87.6	43.8	36	18	89
MN1H-5/2-...-FR											128	98				
ISO size 2																
MN1H-5/2-...	54	38	9	30	M6	116	84	48	9.5	56.5	147.6	123.4	61.7	48	24	98
MN1H-5/2-...-FR											161.5	140.7				
ISO size 3																
MN1H-5/2-...	65	48	12	30	M8	123	91	55	12	63.5	169	145.4	72.7	64	32	109
MN1H-5/2-...-FR											184.8	164.7				

Solenoid valves MN1H, ISO 5599-1

FESTO

Technical data – 5/2-way valves

Ordering data					
Circuit symbol	Description	ISO size	Part No.	Type	
	Without N1 solenoid coil ¹⁾ , internal pilot air supply, pneumatic reset	1	159 688	MN1H-5/2-D-1-C	
				184 637	MN1H-5/2-D-1-C-CT²⁾
		2	159 700	MN1H-5/2-D-2-C	
				184 640	MN1H-5/2-D-2-C-CT²⁾
		3	159 712	MN1H-5/2-D-3-C	
				184 643	MN1H-5/2-D-3-C-CT²⁾
	Without N1 solenoid coil ¹⁾ , external pilot air supply, pneumatic reset	1	159 686	MN1H-5/2-D-1-S-C	
		2	159 698	MN1H-5/2-D-2-S-C	
		3	159 710	MN1H-5/2-D-3-S-C	
	Without N1 solenoid coil ¹⁾ , internal pilot air supply, mechanical reset	1	159 687	MN1H-5/2-D-1-FR-C	
				184 638	MN1H-5/2-D-1-FR-C-CT²⁾
		2	159 699	MN1H-5/2-D-2-FR-C	
				184 641	MN1H-5/2-D-2-FR-C-CT²⁾
		3	159 711	MN1H-5/2-D-3-FR-C	
		184 644	MN1H-5/2-D-3-FR-C-CT²⁾		
	Without N1 solenoid coil ¹⁾ , external pilot air supply, mechanical reset	1	159 716	MN1H-5/2-D-1-FR-S-C	
		2	159 718	MN1H-5/2-D-2-FR-S-C	
		3	160 896	MN1H-5/2-D-3-FR-S-C	



- 1) N1 solenoid coils → 2 / 1.2-100
 2) Free of copper, PTFE and silicone

Standard directional control valves
ISO 5599/1
1.2

Solenoid valves JMN1H, ISO 5599-1

FESTO

Technical data – 5/2-way valves, double solenoid

-  - Flow rate
1200 ... 4500 l/min
-  - Voltage
24 V DC
110, 230, 240 V AC

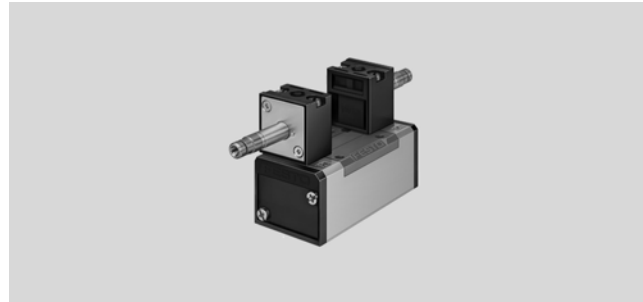

Standard directional control valves
ISO 5599/1
1.2

General technical data				
ISO size	1	2	3	
Valve function	5/2-way, double solenoid			
Constructional design	Piston spool			
Sealing principle	Soft			
Actuation type	Electrical			
Type of reset	Mechanical spring			
Type of pilot control	Piloted			
Pilot air supply	Internal or external			
Direction of flow	Non-reversible			
Exhaust function	With flow control			
Manual override	Via accessory, detenting			
Type of mounting	Via through-holes			
Mounting position	Any			
Nominal size	[mm]	8	11	14.5
Standard nominal flow rate	[l/min]	1200	2300	4500
Grid dimension	[mm]	43	56	71
Pneumatic connection on sub-base		G $\frac{3}{4}$	G $\frac{3}{8}$	G $\frac{1}{2}$
Product weight	[g]	610	880	1090
Noise level	[dB (A)]	85		

Operating and environmental conditions				
Operating medium	Filtered compressed air, lubricated or unlubricated Vacuum			
Operating pressure	Internal pilot air supply	[bar]	2 ... 10	
	External pilot air supply	[bar]	-0.9 ... +16	
Pilot pressure		[bar]	2 ... 10	
Ambient temperature		[°C]	-10 ... +50	
Temperature of medium		[°C]	-10 ... +50	

Valve response times						
ISO size	1		2		3	
		Dominant signal at 14		Dominant signal at 14		Dominant signal at 14
	18	12: 18 ms; 14: 15 ms	21	12: 24 ms; 14: 21 ms	21	12: 24 ms; 14: 21 ms

Solenoid valves JMN1H, ISO 5599-1

Technical data – 5/2-way valves, double solenoid

Electrical data			
N1 solenoid coil			
Electrical connection			Plug, square design to EN 175301-803, type A
Operating voltage	D.C. voltage	[V DC]	24
	A.C. voltage	[V AC]	110/230 (50 ... 60 Hz)
Coil characteristics	D.C. voltage	[W]	2.5
	A.C. voltage	[VA]	Pull: 7.5 Hold: 5
Protection class to EN 60 529			IP65

Materials

Sectional view

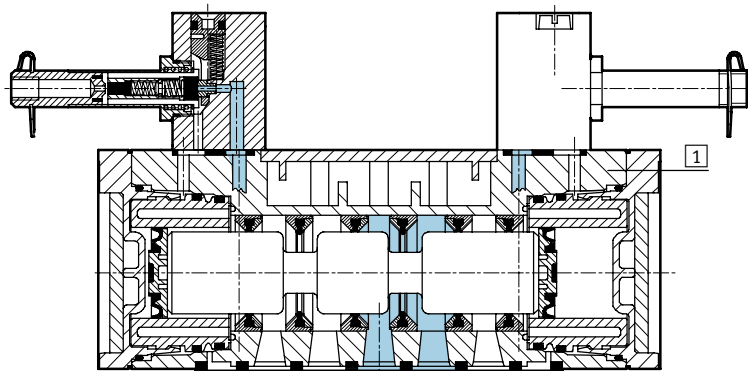

[1]	Housing	Die-cast aluminium, polyacetate
-	Seals	Nitrile rubber

Solenoid valves JMN1H, ISO 5599-1

Technical data – 5/2-way valves, double solenoid



Standard directional control valves
ISO 5599/1
1.2

Dimensions

Download CAD data → www.festo.com/en/engineering

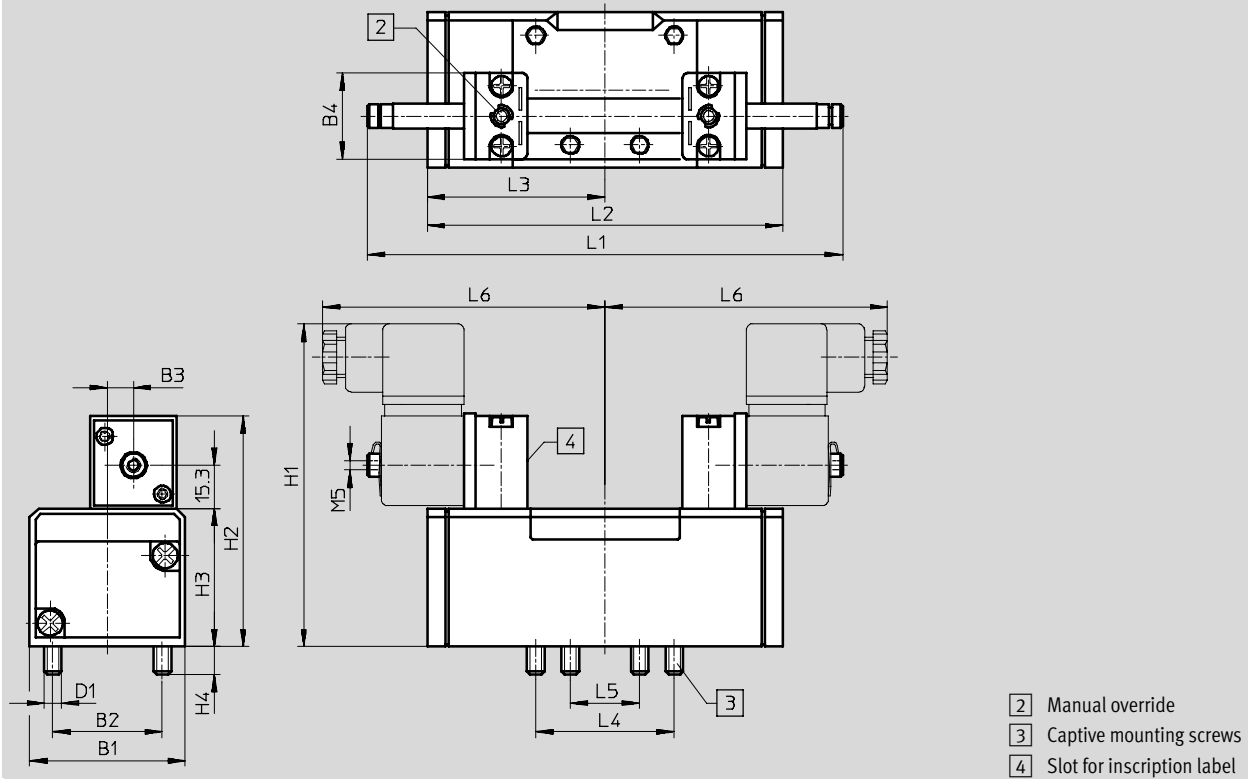

ISO size	B1	B2	B3	B4	D1	H1	H2	H3	H4	L1	L2	L3	L4	L5	L6
1	42	28	6	30	M5	106	74	38	9	147.3	87.6	43.8	36	18	89
2	54	38	9	30	M6	116	84	48	9.5	165	123.4	61.7	48	24	98
3	65	48	12	30	M8	123	91	55	12	185.7	145.4	72.7	64	32	109

Solenoid valves JMN1H, ISO 5599-1

Technical data – 5/2-way valves, double solenoid



Ordering data – Double solenoid valve				
Circuit symbol	Description	ISO size	Part No.	Type
	Without N1 solenoid coil ¹⁾ , internal pilot air supply	1	159 690	JMN1H-5/2-D-1-C
		2	159 702	JMN1H-5/2-D-2-C
		3	159 714	JMN1H-5/2-D-3-C
	Without N1 solenoid coil ¹⁾ , external pilot air supply	1	159 689	JMN1H-5/2-D-1-S-C
		2	159 701	JMN1H-5/2-D-2-S-C
		3	159 713	JMN1H-5/2-D-3-S-C
	Without N1 solenoid coil ¹⁾ , internal pilot air supply, with dominant signal at 14	1	159 691	JMN1DH-5/2-D-1-C
		2	159 703	JMN1DH-5/2-D-2-C
		3	159 715	JMN1DH-5/2-D-3-C
	Without N1 solenoid coil ¹⁾ , external pilot air supply, with dominant signal at 14	1	159 717	JMN1DH-5/2-D-1-S-C
		2	159 719	JMN1DH-5/2-D-2-S-C
		3	160 897	JMN1DH-5/2-D-3-S-C

1) N1 solenoid coils → 2 / 1.2-100

Solenoid valves MN1H, ISO 5599-1

Technical data – 5/3-way valves

FESTO

-  - Flow rate
1200 ... 4600 l/min
-  - Voltage
24 V DC
110, 230 V AC

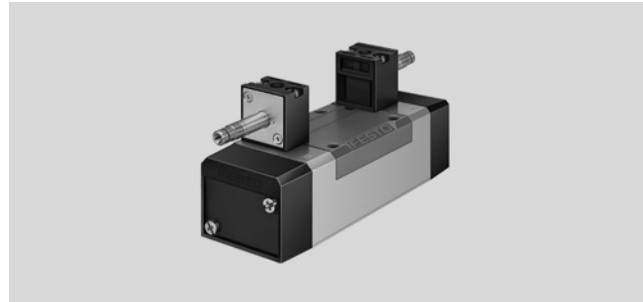

Standard directional control valves
ISO 5599/1
1.2

General technical data					
ISO size		1	2	3	
Valve function		5/3-way, single solenoid			
Constructional design		Piston spool			
Sealing principle		Soft			
Actuation type		Electrical			
Type of reset		Mechanical spring			
Type of pilot control		Piloted			
Pilot air supply		Internal			
Direction of flow		Non-reversible			
Exhaust function		With flow control			
Manual override		Via accessory, detenting			
Type of mounting		Via through-holes			
Mounting position		Any			
Nominal size		[mm]	8	11	14.5
Standard nominal flow rate	Closed	[l/min]	1200	2300	4100
	Exhausted	[l/min]			4600
	Pressurised	[l/min]			4000
Grid dimension		[mm]	43	56	71
Pneumatic connection on sub-base			G $\frac{3}{4}$	G $\frac{3}{8}$	G $\frac{1}{2}$
Product weight		[g]	650	940	1170
Noise level		[dB (A)]	85		

Operating and environmental conditions			
Operating medium		Filtered compressed air, lubricated or unlubricated Vacuum	
Operating pressure	Internal pilot air supply	[bar]	3 ... 10
	External pilot air supply	[bar]	-0.9 ... +16
Pilot pressure		[bar]	3 ... 10
Ambient temperature		[°C]	-10 ... +50
Temperature of medium		[°C]	-10 ... +50

Valve response times [ms]						
ISO size	1		2		3	
	On	Off	On	Off	On	Off
With N1 solenoid coil						
Closed	20	44	33	82	33	82
Exhausted	20	46	36	84	36	84
Pressurised	20	46	35	78	35	78

Solenoid valves MN1H, ISO 5599-1

FESTO

Technical data – 5/3-way valves

Electrical data			
N1 solenoid coil			
Electrical connection			Plug, square design to EN 175301-803, type A
Operating voltage	D.C. voltage	[V DC]	24
	A.C. voltage	[V AC]	110/230 (50 ... 60 Hz)
Coil characteristics	D.C. voltage	[W]	2.5
	A.C. voltage	[VA]	Pull: 7.5 Hold: 5
Protection class to EN 60 529			IP65

Materials

Sectional view

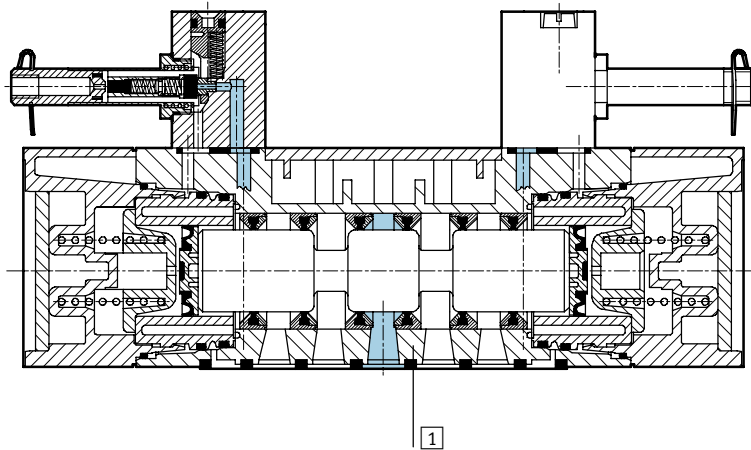

1	Housing	Die-cast aluminium, polyacetate
-	Seals	Nitrile rubber
	Note on material	Versions free of copper, PTFE and silicone → Ordering data

Standard directional control valves
ISO 5599/1

1.2

Solenoid valves MN1H, ISO 5599-1

Technical data – 5/3-way valves

FESTO

Standard directional control valves
ISO 5599/1
1.2

Dimensions

Download CAD data → www.festo.com/en/engineering

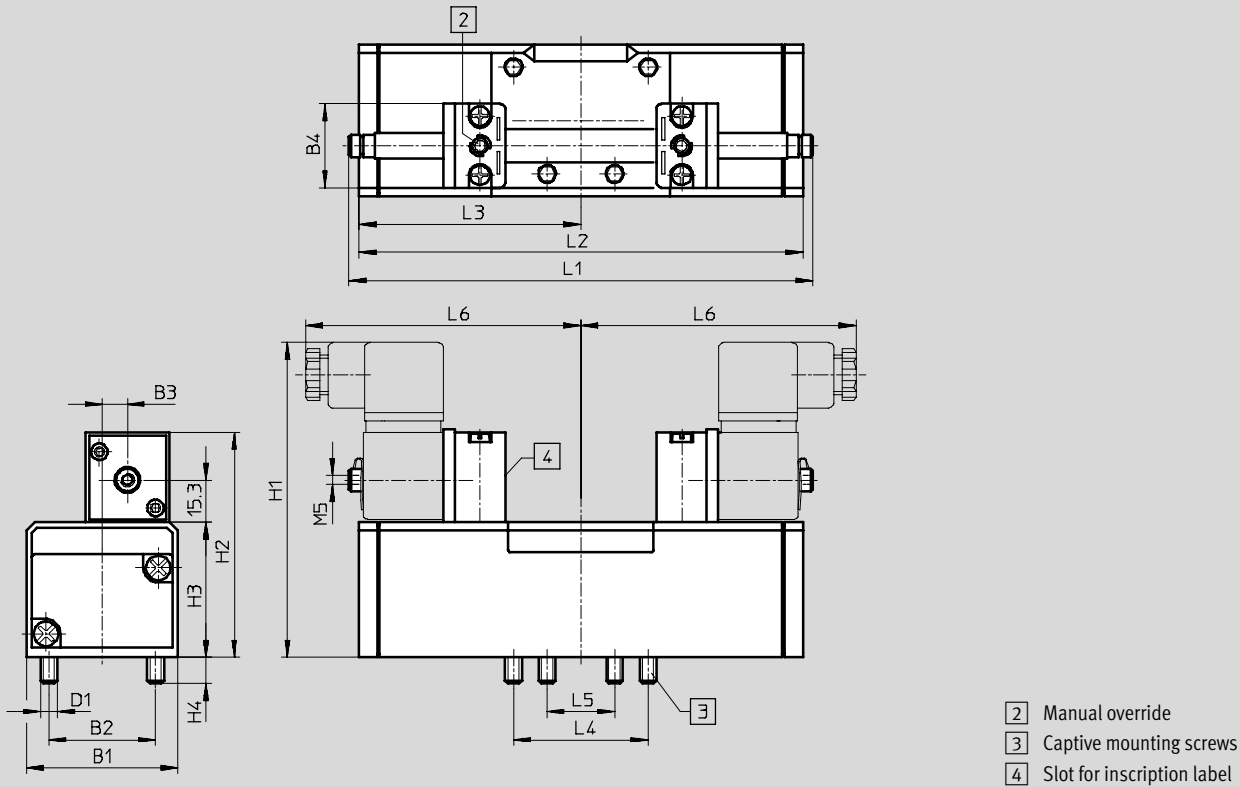

ISO size	B1	B2	B3	B4	D1	H1	H2	H3	H4	L1	L2	L3	L4	L5	L6
1	42	28	6	30	M5	106	74	38	9	147.3	108.4	54.2	36	18	89
2	54	38	9	30	M6	116	84	48	9.5	165	158	79	48	24	98
3	65	48	12	30	M8	123	91	55	12	185.7	184	92	64	32	109

Solenoid valves MN1H, ISO 5599-1

Technical data – 5/3-way valves

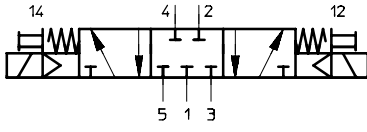
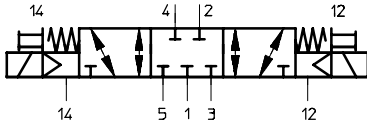
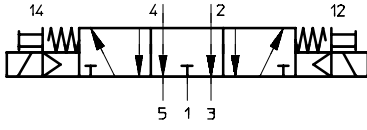
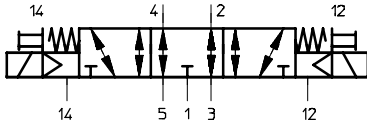
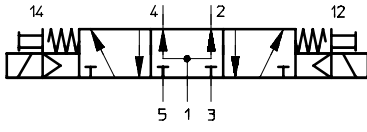
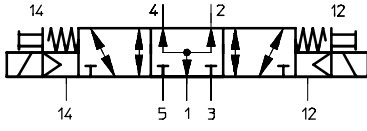

Ordering data				
Circuit symbol	Description	ISO size	Part No.	Type
	Without N1 solenoid coil ¹⁾ , normally closed, internal pilot air supply	1	159 681	MN1H-5/3G-D-1-C
			184 658	MN1H-5/3G-D-1-C-CT ²⁾
		2	159 693	MN1H-5/3G-D-2-C
			184 660	MN1H-5/3G-D-2-C-CT ²⁾
		3	159 705	MN1H-5/3G-D-3-C
			184 662	MN1H-5/3G-D-3-C-CT ²⁾
	Without N1 solenoid coil ¹⁾ , normally closed, external pilot air supply	1	159 680	MN1H-5/3G-D-1-S-C
		2	159 692	MN1H-5/3G-D-2-S-C
		3	159 704	MN1H-5/3G-D-3-S-C
	Without N1 solenoid coil ¹⁾ , normally exhausted, internal pilot air supply	1	159 683	MN1H-5/3E-D-1-C
			184 652	MN1H-5/3E-D-1-C-CT ²⁾
		2	159 695	MN1H-5/3E-D-2-C
			184 654	MN1H-5/3E-D-2-C-CT ²⁾
		3	159 707	MN1H-5/3E-D-3-C
			184 656	MN1H-5/3E-D-3-C-CT ²⁾
	Without N1 solenoid coil ¹⁾ , normally exhausted, external pilot air supply	1	159 682	MN1H-5/3E-D-1-S-C
		2	159 694	MN1H-5/3E-D-2-S-C
		3	159 706	MN1H-5/3E-D-3-S-C
	Without N1 solenoid coil ¹⁾ , normally pressurised, internal pilot air supply	1	159 685	MN1H-5/3B-D-1-C
			184 646	MN1H-5/3B-D-1-C-CT ²⁾
		2	159 697	MN1H-5/3B-D-2-C
			184 648	MN1H-5/3B-D-2-C-CT ²⁾
		3	159 709	MN1H-5/3B-D-3-C
			184 650	MN1H-5/3B-D-3-C-CT ²⁾
	Without N1 solenoid coil ¹⁾ , normally pressurised, external pilot air supply	1	159 684	MN1H-5/3B-D-1-S-C
		2	159 696	MN1H-5/3B-D-2-S-C
		3	159 708	MN1H-5/3B-D-3-S-C

1) N1 solenoid coils → 2 / 1.2-100
 2) Free of copper, PTFE and silicone

Solenoid valves MFH, ISO 5599-1

FESTO

Technical data – 5/2-way valves

-  - Flow rate
1200 ... 4500 l/min
-  - Voltage
12, 24, 42, 48 V DC
24, 42, 48, 110, 230,
240 V AC



Standard directional control valves
ISO 5599/1
1.2

General technical data				
ISO size	1	2	3	
Valve function	5/2-way, single solenoid			
Constructional design	Piston spool			
Sealing principle	Soft			
Actuation type	Electrical			
Type of reset	Mechanical or pneumatic spring			
Type of pilot control	Piloted			
Pilot air supply	Internal			
Direction of flow	Non-reversible			
Exhaust function	With flow control			
Manual override	Via accessory, detenting			
Type of mounting	Via through-holes			
Mounting position	Any			
Nominal size	[mm]	8	11	14.5
Standard nominal flow rate	[l/min]	1200	2300	4500
Grid dimension	[mm]	43	56	71
Pneumatic connection on sub-base		G $\frac{3}{4}$	G $\frac{3}{8}$	G $\frac{1}{2}$
Product weight	[g]	390	650	960
Noise level	[dB (A)]	85		

Operating and environmental conditions			
Type of reset		Pneumatic	Mechanical
Operating medium		Filtered compressed air, lubricated or unlubricated Vacuum	
Operating pressure	Internal pilot air supply [bar]	2 ... 10	3 ... 10
	External pilot air supply [bar]	-0.9 ... +16	-0.9 ... +16
Pilot pressure	[bar]	2 ... 10	3 ... 10
Ambient temperature	[°C]	-5 ... +40	
Temperature of medium	[°C]	-10 ... +60	

Valve response times [ms]						
ISO size	1		2		3	
Type of reset	Pneumatic	Mechanical	Pneumatic	Mechanical	Pneumatic	Mechanical
With F solenoid coil						
On	23	16	48	27	60	30
Off	35	45	71	73	66	82

Solenoid valves MFH, ISO 5599-1

Technical data – 5/2-way valves

Electrical data			
F solenoid coil			
Electrical connection	Design		Plug vanes for plug sockets MSSD-F, KMF
Operating voltage	D.C. voltage	[V DC]	12, 24, 42, 48
	A.C. voltage	[V AC]	24, 42, 48, 110, 230, 240 (50 ... 60 Hz)
Coil characteristics	D.C. voltage	[W]	4.5
	A.C. voltage	[VA]	Pull: 7.5 Hold: 6
Protection class to EN 60 529			IP65

Materials

Sectional view

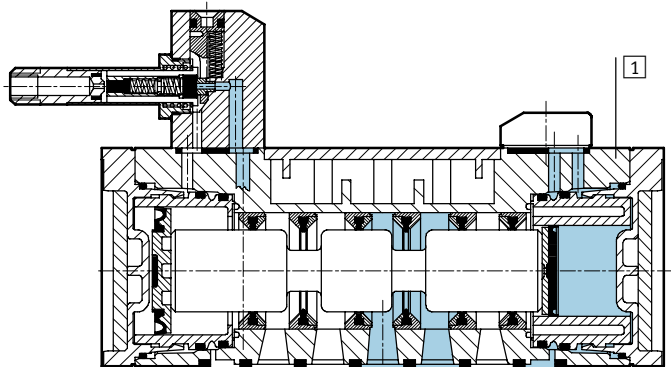

1	Housing	Die-cast aluminium, polyacetate
-	Seals	Nitrile rubber

Solenoid valves MFH, ISO 5599-1

Technical data – 5/2-way valves



Standard directional control valves
ISO 5599/1
1.2

Dimensions

Download CAD data → www.festo.com/en/engineering

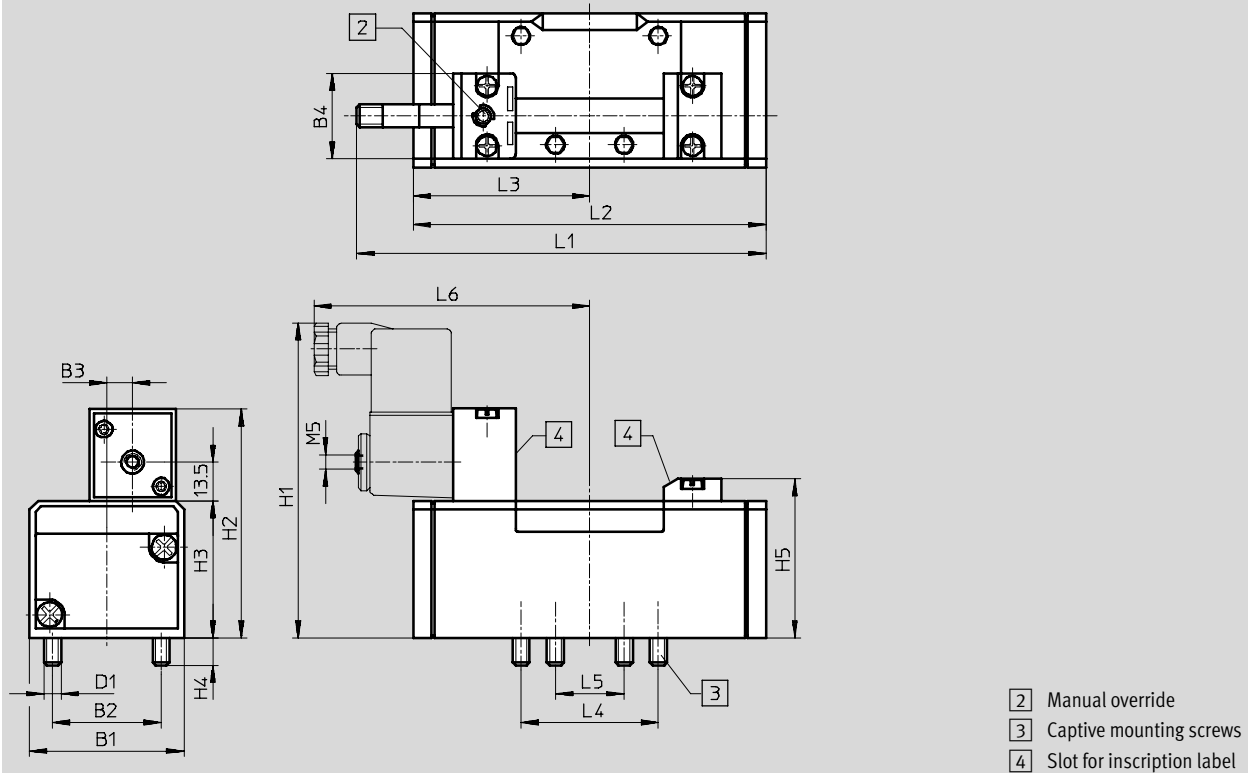

Type	B1	B2	B3	B4	D1	H1	H2	H3	H4	H5	L1	L2	L3	L4	L5	L6
ISO size 1																
MFH-5/2-...	42	28	6	30	M5	100	70.3	38	9	46.5	115	87.6	43.8	36	18	89
MFH-5/2-...-FR											125.6	98				
ISO size 2																
MFH-5/2-...	54	38	9	30	M6	110	80.3	48	9.5	56.5	142	123.4	61.7	48	24	98
MFH-5/2-...-FR											159.4	140.7				
ISO size 3																
MFH-5/2-...	65	48	12	30	M8	117	87.3	55	12	63.5	163	145.4	72.7	64	32	109
MFH-5/2-...-FR											182	164.7				

Solenoid valves MFH, ISO 5599-1

Technical data – 5/2-way valves



Ordering data				
Circuit symbol	Description	ISO size	Part No.	Type
	Without F solenoid coil ¹⁾ , pneumatic reset, internal pilot air supply	1	150 981	MFH-5/2-D-1-C
		2	151 851	MFH-5/2-D-2-C
		3	151 870	MFH-5/2-D-3-C
	Without F solenoid coil ¹⁾ , pneumatic reset, external pilot air supply	1	152 562	MFH-5/2-D-1-S-C
		2	151 022	MFH-5/2-D-2-S-C
		3	151 032	MFH-5/2-D-3-S-C
	Without F solenoid coil ¹⁾ , mechanical reset, internal pilot air supply	1	151 016	MFH-5/2-D-1-FR-C
		2	151 709	MFH-5/2-D-2-FR-C
		3	151 711	MFH-5/2-D-3-FR-C

1) F solenoid coils → 2 / 1.2-100

Solenoid valves JMFH, ISO 5599-1

Technical data – 5/2-way valves, double solenoid



-  - Flow rate
1200 ... 4500 l/min
-  - Voltage
12, 24, 42, 48 V DC
24, 42, 48, 110, 230,
240 V AC

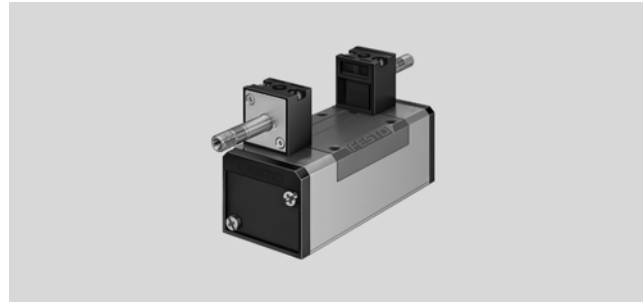

Standard directional control valves
ISO 5599/1

1.2

General technical data				
ISO size	1	2	3	
Valve function	5/2-way, double solenoid			
Constructional design	Piston spool			
Sealing principle	Soft			
Actuation type	Electrical			
Type of pilot control	Piloted			
Pilot air supply	Internal or external			
Direction of flow	Non-reversible			
Exhaust function	With flow control			
Manual override	Via accessory, detenting			
Type of mounting	Via through-holes			
Mounting position	Any			
Nominal size	[mm]	8	11	14.5
Standard nominal flow rate	[l/min]	1200	2300	4500
Grid dimension	[mm]	43	56	71
Pneumatic connection on sub-base		G $\frac{3}{4}$	G $\frac{3}{8}$	G $\frac{1}{2}$
Product weight	[g]	490	750	1060
Noise level	[dB (A)]	85		

Operating and environmental conditions			
Operating medium	Filtered compressed air, lubricated or unlubricated Vacuum		
Operating pressure	Internal pilot air supply	[bar]	2 ... 10
	External pilot air supply	[bar]	-0.9 ... +16
Pilot pressure		[bar]	2 ... 10
Ambient temperature		[°C]	-5 ... +40
Temperature of medium		[°C]	-10 ... +60

Valve response times [ms]						
ISO size	1		2		3	
		Dominant signal at 14		Dominant signal at 14		Dominant signal at 14
With F solenoid coil						
	16	16	18	18	18	18

Solenoid valves JMFH, ISO 5599-1

Technical data – 5/2-way valves, double solenoid

Electrical data			
ISO size		1, 2, 3	
F solenoid coil			
Electrical connection	Design	Plug vanes for plug sockets MSSD-F, KMF	
Operating voltage	D.C. voltage	[V DC]	12, 24, 42, 48
	A.C. voltage	[V AC]	24, 42, 48, 110, 230, 240 (50 ... 60 Hz)
Coil characteristics	D.C. voltage	[W]	4.5
	A.C. voltage	[VA]	Pull: 7.5 Hold: 6
Protection class to EN 60 529		IP65	

Materials

Sectional view

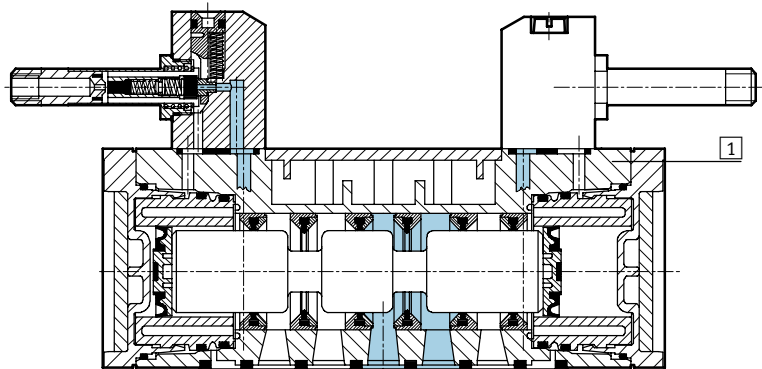

1	Housing	Die-cast aluminium, polyacetate
-	Seals	Nitrile rubber

Solenoid valves JMFH, ISO 5599-1

Technical data – 5/2-way valves, double solenoid



Dimensions

Download CAD data → www.festo.com/en/engineering

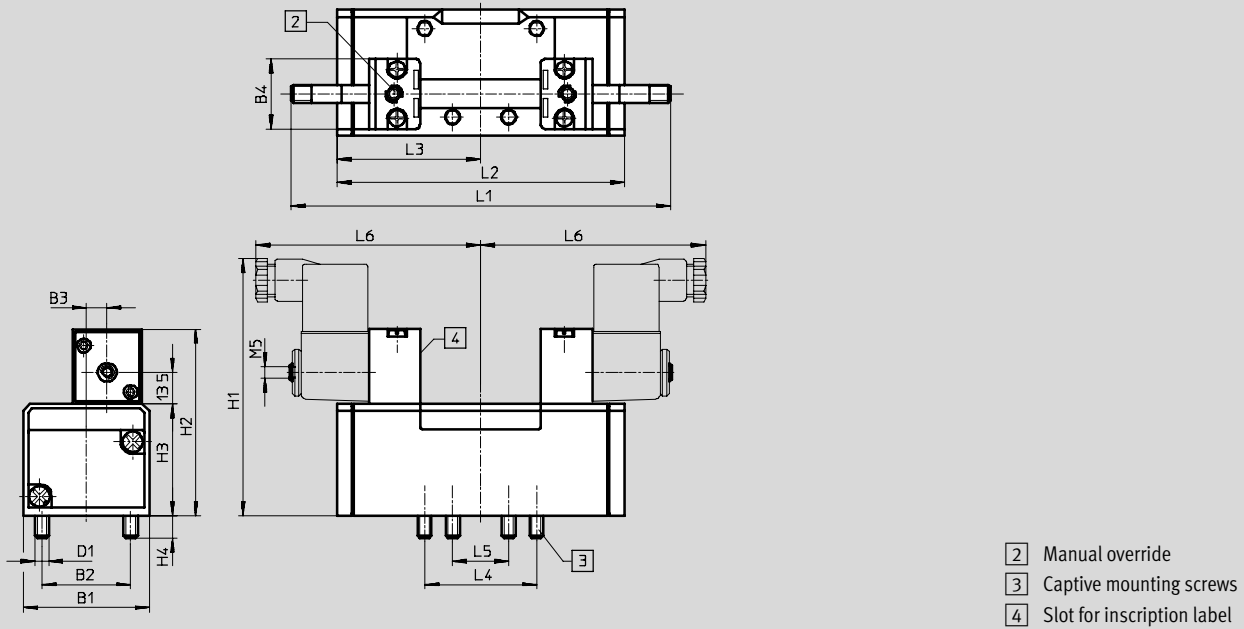

ISO size	B1	B2	B3	B4	D1	H1	H2	H3	H4	L1	L2	L3	L4	L5	L6
1	42	28	6	30	M5	100	70.3	38	9	142.6	87.6	43.8	36	18	88
2	54	38	9	30	M6	110	80.3	48	9.5	160.4	123.4	61.7	48	24	97
3	65	48	12	30	M8	117	87.3	55	12	181	145.4	72.7	64	32	109

Ordering data



Circuit symbol	Description	ISO size	Part No.	Type
	Without F solenoid coil ¹⁾ , internal pilot air supply	1	150 980	JMFH-5/2-D-1-C
		2	151 852	JMFH-5/2-D-2-C
		3	151 871	JMFH-5/2-D-3-C
	Without F solenoid coil ¹⁾ , external pilot air supply	1	152 563	JMFH-5/2-D-1-S-C
		2	151 023	JMFH-5/2-D-2-S-C
		3	151 033	JMFH-5/2-D-3-S-C
	Without F solenoid coil ¹⁾ , internal pilot air supply, with dominant signal at 14	1	151 019	JMFDH-5/2-D-1-C
		2	151 853	JMFDH-5/2-D-2-C
		3	151 872	JMFDH-5/2-D-3-C

1) F solenoid coils → 2 / 1.2-100

Solenoid valves MFH, ISO 5599-1

FESTO

Technical data – 5/3-way valves

-  - Flow rate
1200 ... 4600 l/min
-  - Voltage
12, 24, 42, 48 V DC
24, 42, 48, 110, 230,
240 V AC

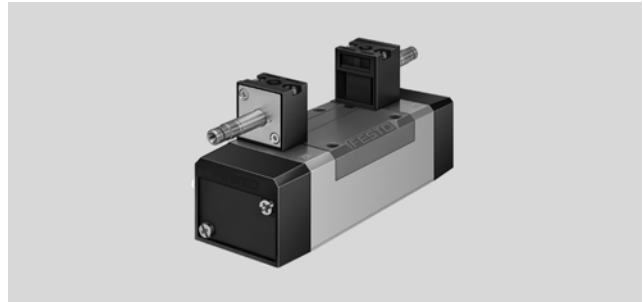

General technical data					
ISO size		1	2	3	
Valve function		5/3-way, single solenoid			
Constructional design		Piston spool			
Sealing principle		Soft			
Actuation type		Electrical			
Type of reset		Mechanical spring			
Type of pilot control		Piloted			
Pilot air supply		Internal or external			
Direction of flow		Non-reversible			
Exhaust function		With flow control			
Manual override		Via accessory, detenting			
Type of mounting		Via through-holes			
Mounting position		Any			
Nominal size		[mm]	8	11	14.5
Standard nominal flow rate	Closed	[l/min]	1200	2300	4100
	Exhausted	[l/min]			4600
	Pressurised	[l/min]			4000
Grid dimension		[mm]	43	56	71
Pneumatic connection on sub-base			G $\frac{3}{4}$	G $\frac{3}{8}$	G $\frac{1}{2}$
Product weight		[g]	520	820	1040
Noise level		[dB (A)]	85		

Operating and environmental conditions			
Operating medium		Filtered compressed air, lubricated or unlubricated Vacuum	
Operating pressure	Internal pilot air supply	[bar]	3 ... 10
	External pilot air supply	[bar]	-0.9 ... +16
Pilot pressure		[bar]	3 ... 10
Ambient temperature		[°C]	-5 ... +40
Temperature of medium		[°C]	-10 ... +60

Valve response times [ms]							
ISO size		1		2		3	
		On	Off	On	Off	On	Off
With F solenoid coil							
Closed		18	36	33	63	36	77
Exhausted		18	36	35	67	37	78
Pressurised		18	36	35	69	36	75

Standard directional control valves
ISO 5599/1

1.2

Solenoid valves MFH, ISO 5599-1

FESTO

Technical data – 5/3-way valves

Standard directional control valves
ISO 5599/1
1.2

Electrical data			
F solenoid coil			
Electrical connection	Design		Plug vanes for plug sockets MSSD-F, KMF
Operating voltage	D.C. voltage	[V DC]	12, 24, 42, 48
	A.C. voltage	[V AC]	24, 42, 48, 110, 230, 240 (50 ... 60 Hz)
Coil characteristics	D.C. voltage	[W]	4.5
	A.C. voltage	[VA]	Pull: 7.5 Hold: 6
Protection class to EN 60 529			IP65

Materials

Sectional view

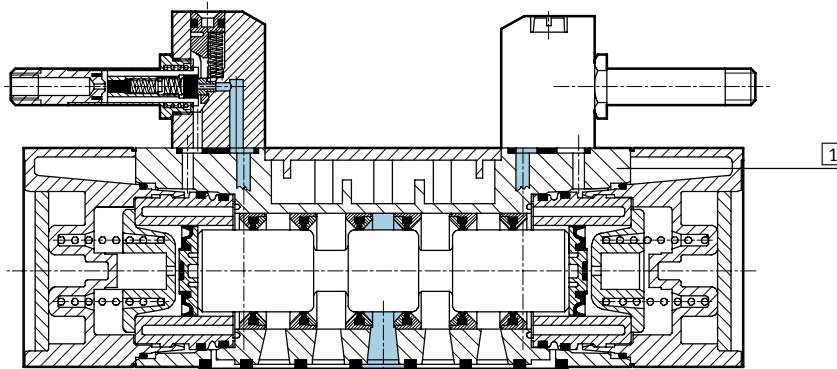

1	Housing	Die-cast aluminium, polyacetate
-	Seals	Nitrile rubber

Solenoid valves MFH, ISO 5599-1

Technical data – 5/3-way valves



Dimensions

Download CAD data → www.festo.com/en/engineering

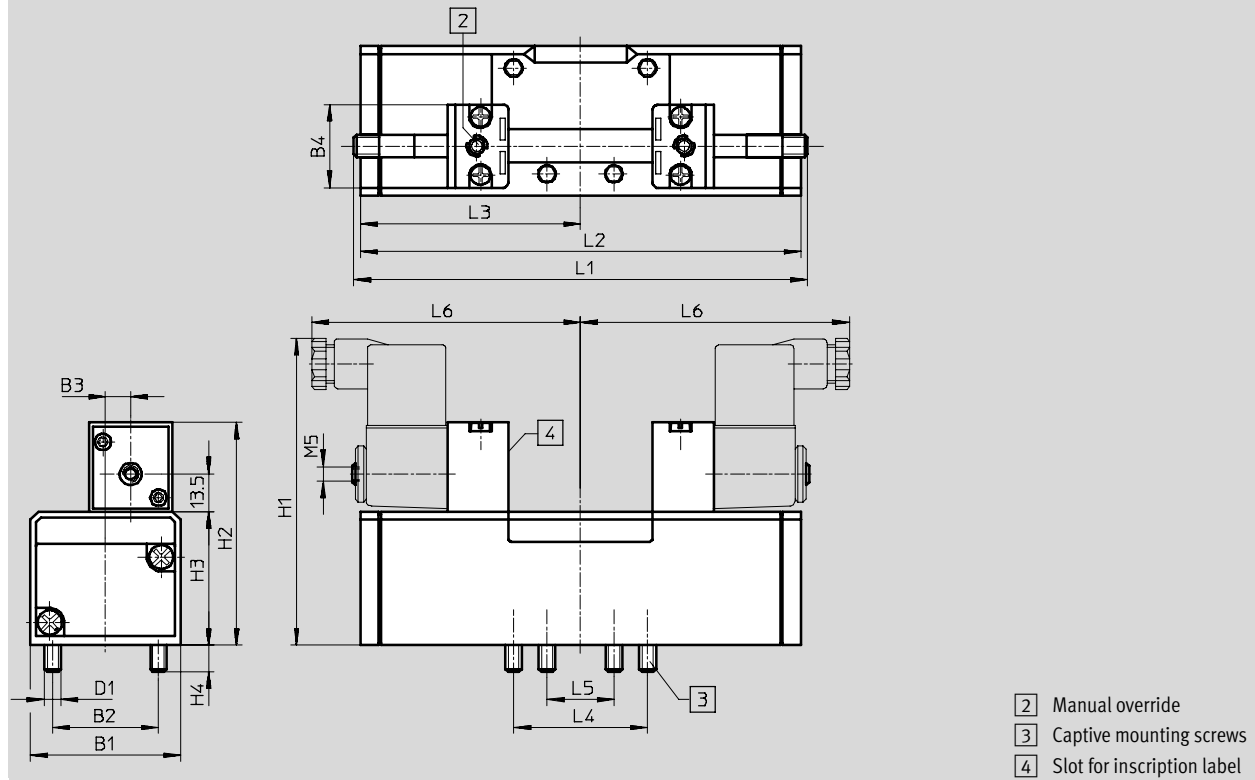

ISO size	B1	B2	B3	B4	D1	H1	H2	H3	H4	L1	L2	L3	L4	L5	L6
1	42	28	6	30	M5	100	70.3	38	9	142.6	108.4	54.2	36	18	89
2	54	38	9	30	M6	110	80.3	48	9.5	160	158	79	48	24	98
3	65	48	12	30	M8	117	87.3	55	12	181	184	92	64	32	109

Standard directional control valves
 ISO 5599/1

1.2

Solenoid valves MFH, ISO 5599-1

Technical data – 5/3-way valves

Standard directional control valves
ISO 5599/1

1.2

Ordering data				
Circuit symbol	Description	ISO size	Part No.	Type
	Without F solenoid coil ¹⁾ , normally closed, internal pilot air supply	1	150 982	MFH-5/3G-D-1-C
		2	151 854	MFH-5/3G-D-2-C
		3	151 873	MFH-5/3G-D-3-C
	Without F solenoid coil ¹⁾ , normally closed, external pilot air supply	1	152 564	MFH-5/3G-D-1-S-C
		2	151 024	MFH-5/3G-D-2-S-C
		3	151 034	MFH-5/3G-D-3-S-C
	Without F solenoid coil ¹⁾ , normally exhausted, internal pilot air supply	1	150 983	MFH-5/3E-D-1-C
		2	151 855	MFH-5/3E-D-2-C
		3	151 874	MFH-5/3E-D-3-C
	Without F solenoid coil ¹⁾ , normally exhausted, external pilot air supply	1	152 565	MFH-5/3E-D-1-S-C
		2	151 025	MFH-5/3E-D-2-S-C
		3	151 035	MFH-5/3E-D-3-S-C
	Without F solenoid coil ¹⁾ , normally pressurised, internal pilot air supply	1	150 984	MFH-5/3B-D-1-C
		2	151 856	MFH-5/3B-D-2-C
		3	151 875	MFH-5/3B-D-3-C
	Without F solenoid coil ¹⁾ , normally pressurised, external pilot air supply	1	152 566	MFH-5/3B-D-1-S-C
		2	151 026	MFH-5/3B-D-2-S-C
		3	151 036	MFH-5/3B-D-3-S-C

1) F solenoid coils → 2 / 1.2-100

Solenoid valves MEBH, ISO 5599-1

FESTO

Technical data – 5/2-way valves

-  - Flow rate
1200 ... 4500 l/min

-  - Voltage
24 V DC



General technical data				
ISO size	1		2	3
Valve function	5/2-way, single solenoid			
Constructional design	Piston spool			
Sealing principle	Soft			
Actuation type	Electrical			
Type of reset	Mechanical or pneumatic spring			
Type of pilot control	Piloted			
Pilot air supply	Internal			
Direction of flow	Non-reversible			
Exhaust function	With flow control			
Manual override	Via accessory, detenting			
Type of mounting	Via through-holes			
Mounting position	Any			
Nominal size	[mm]	8	11	14.5
Standard nominal flow rate	[l/min]	1200	2300	4500
Grid dimension	[mm]	43	56	71
Pneumatic connection on sub-base		G $\frac{3}{4}$	G $\frac{3}{8}$	G $\frac{1}{2}$
Product weight	[g]	550	700	1000
Noise level	[dB (A)]	85		

Operating and environmental conditions				
Type of reset			Pneumatic	Mechanical
Operating medium			Filtered compressed air, lubricated or unlubricated Vacuum	
Operating pressure	Internal pilot air supply	[bar]	2 ... 10	3 ... 10
	External pilot air supply	[bar]	-0.9 ... +16	-0.9 ... +16
Pilot pressure		[bar]	2 ... 10	3 ... 10
Ambient temperature		[°C]	-5 ... +50	
Temperature of medium		[°C]	-5 ... +50	

Valve response times [ms]						
ISO size	1		2		3	
Type of reset	Pneumatic	Mechanical	Pneumatic	Mechanical	Pneumatic	Mechanical
With EB solenoid coil						
On	20	15	50	33	59	28
Off	33	50	85	103	87	109

Standard directional control valves
ISO 5599/1

1.2

Solenoid valves MEBH, ISO 5599-1

FESTO

Technical data – 5/2-way valves

Standard directional control valves
ISO 5599/1
1.2

Electrical data			
EB solenoid coil			
Electrical connection	Central plug, round design, M12x1		
Operating voltage	D.C. voltage	[V DC]	24
Coil characteristics	D.C. voltage	[W]	2.5
Protection class to EN 60 529			IP65

Materials

Sectional view

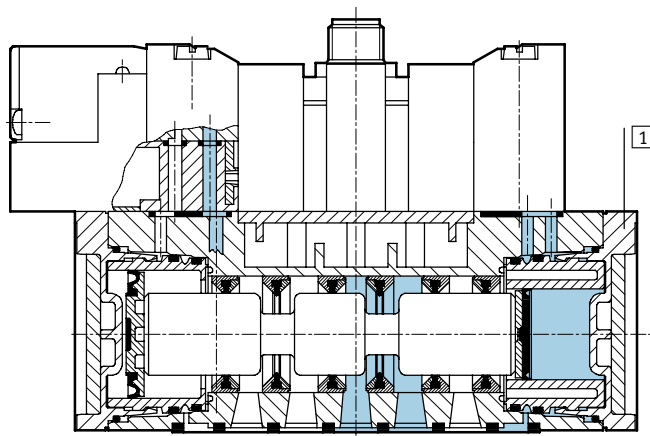

1	Housing	Die-cast aluminium, polyacetate
-	Seals	Nitrile rubber

Solenoid valves MEBH, ISO 5599-1

Technical data – 5/2-way valves



Dimensions

Download CAD data → www.festo.com/en/engineering

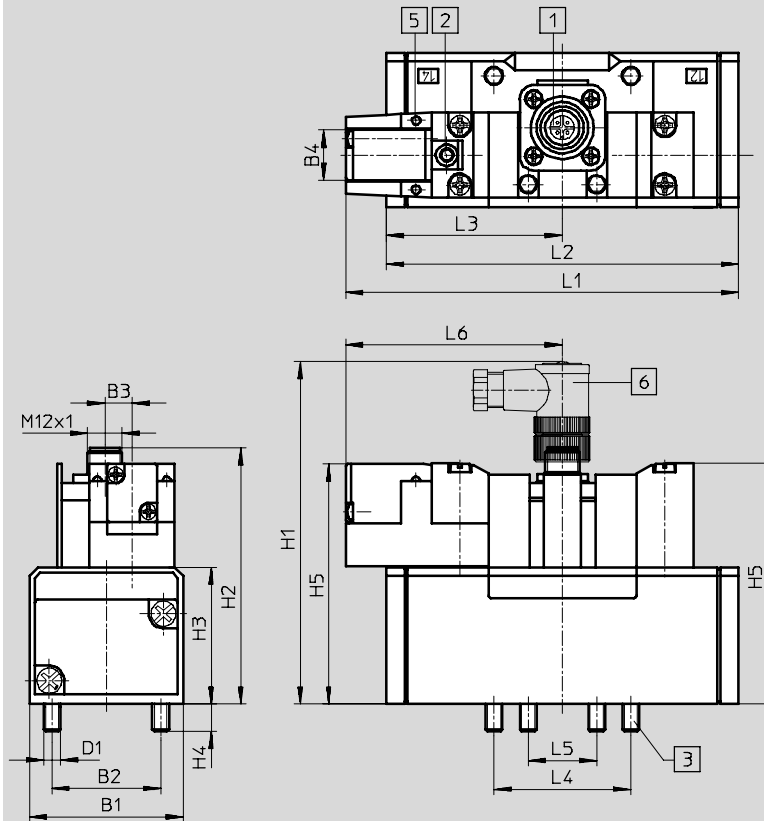

- 1 Attachment of plug socket adjustable by 3x 30°
- 2 Manual override
- 3 Captive mounting screws
- 5 LED display
- 6 Angled socket SEA-M12-4WD-PG7 → 2 / 1.2-102

Type	B1	B2	B3	B4	D1	H1	H2	H3	H4	H5	L1	L2	L3	L4	L5	L6
ISO size 1																
MEBH-5/2-...	42	28	6	17.5	M5	110	80.3	38	9	74.7	110.8	87.6	43.8	36	18	67
MEBH-5/2-...-FR											121.3	98				
ISO size 2																
MEBH-5/2-...	54	38	9	17.5	M6	120	90.1	48	9.5	84.2	137.6	123.4	61.7	48	24	75.9
MEBH-5/2-...-FR											154.9	140.7				
ISO size 3																
MEBH-5/2-...	65	48	12	17.5	M8	130	97.8	55	12	93.1	158.7	145.4	72.7	64	32	86
MEBH-5/2-...-FR											178	164.7				

M12 central plug – Terminal allocation

Mono connection

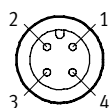

- 1 Unused
- 2 Unused
- 3 com (-)
- 4 Signal (+) Solenoid 14

Standard directional control valves
ISO 5599/1

1.2

Solenoid valves MEBH, ISO 5599-1



Technical data – 5/2-way valves

Standard directional control valves
ISO 5599/1

1.2

Ordering data					
Circuit symbol	Description	Voltage	ISO size	Part No.	Type
	With EB solenoid coil, with central plug, pneumatic reset, internal pilot air supply	24 V DC	1	184 493	MEBH-5/2-D-1-ZSR-C
			2	184 500	MEBH-5/2-D-2-ZSR-C
			3	184 507	MEBH-5/2-D-3-ZSR-C
	With EB solenoid coil, with central plug, mechanical reset, internal pilot air supply	24 V DC	1	184 494	MEBH-5/2-D-1-ZSR-FR-C
			2	184 501	MEBH-5/2-D-2-ZSR-FR-C
			3	184 508	MEBH-5/2-D-3-ZSR-FR-C

Solenoid valves JMEBH, ISO 5599-1

FESTO

Technical data – 5/2-way valves, double solenoid

-  - Flow rate
1200 ... 4500 l/min

-  - Voltage
24 V DC

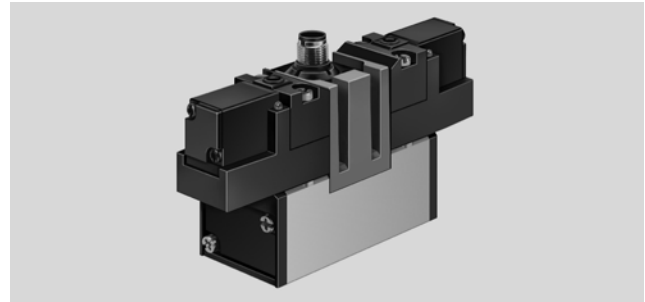

General technical data				
ISO size	1	2	3	
Valve function	5/2-way, double solenoid			
Constructional design	Piston spool			
Sealing principle	Soft			
Actuation type	Electrical			
Type of pilot control	Piloted			
Pilot air supply	Internal or external			
Direction of flow	Non-reversible			
Exhaust function	With flow control			
Manual override	Via accessory, detenting			
Type of mounting	Via through-holes			
Mounting position	Any			
Nominal size	[mm]	8	11	14.5
Standard nominal flow rate	[l/min]	1200	2300	4500
Grid dimension	[mm]	43	56	71
Pneumatic connection on sub-base		G $\frac{3}{4}$	G $\frac{3}{8}$	G $\frac{1}{2}$
Product weight	[g]	600	770	1080
Noise level	[dB (A)]	85		

Operating and environmental conditions			
Operating medium	Filtered compressed air, lubricated or unlubricated Vacuum		
Operating pressure	Internal pilot air supply	[bar]	2 ... 10
	External pilot air supply	[bar]	-0.9 ... +16
Pilot pressure		[bar]	2 ... 10
Ambient temperature		[°C]	-5 ... +50
Temperature of medium		[°C]	-5 ... +50

Valve response times [ms]						
ISO size	1		2		3	
		Dominant signal at 14		Dominant signal at 14		Dominant signal at 14
With EB solenoid coil						
Changeover	12	13	15	23	16	20

Standard directional control valves
ISO 5599/1

1.2

Solenoid valves JMEBH, ISO 5599-1

FESTO

Technical data – 5/2-way valves, double solenoid

Standard directional control valves
ISO 5599/1
1.2

Electrical data			
EB solenoid coil			
Electrical connection	Design	Central plug, round design, M12x1	
Operating voltage	D.C. voltage	[V DC]	24
Coil characteristics	D.C. voltage	[W]	2.5
Protection class to EN 60 529			IP65

Materials

Sectional view

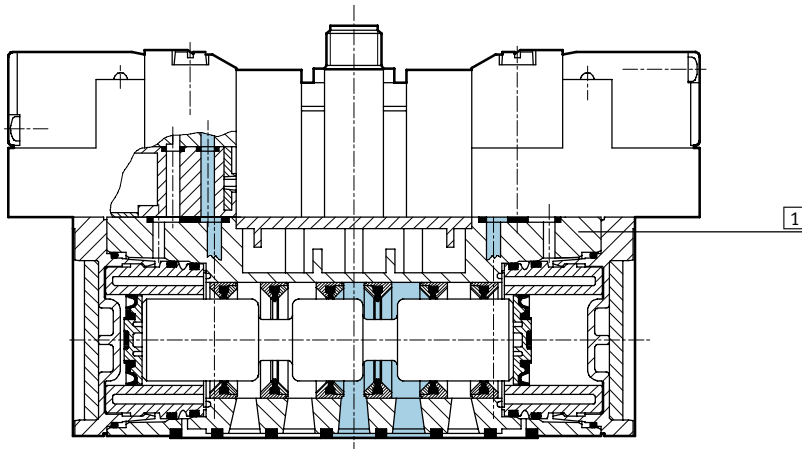

1	Housing	Die-cast aluminium, polyacetate
-	Seals	Nitrile rubber

Solenoid valves JMEBH, ISO 5599-1

Technical data – 5/2-way valves, double solenoid



Dimensions

Download CAD data → www.festo.com/en/engineering

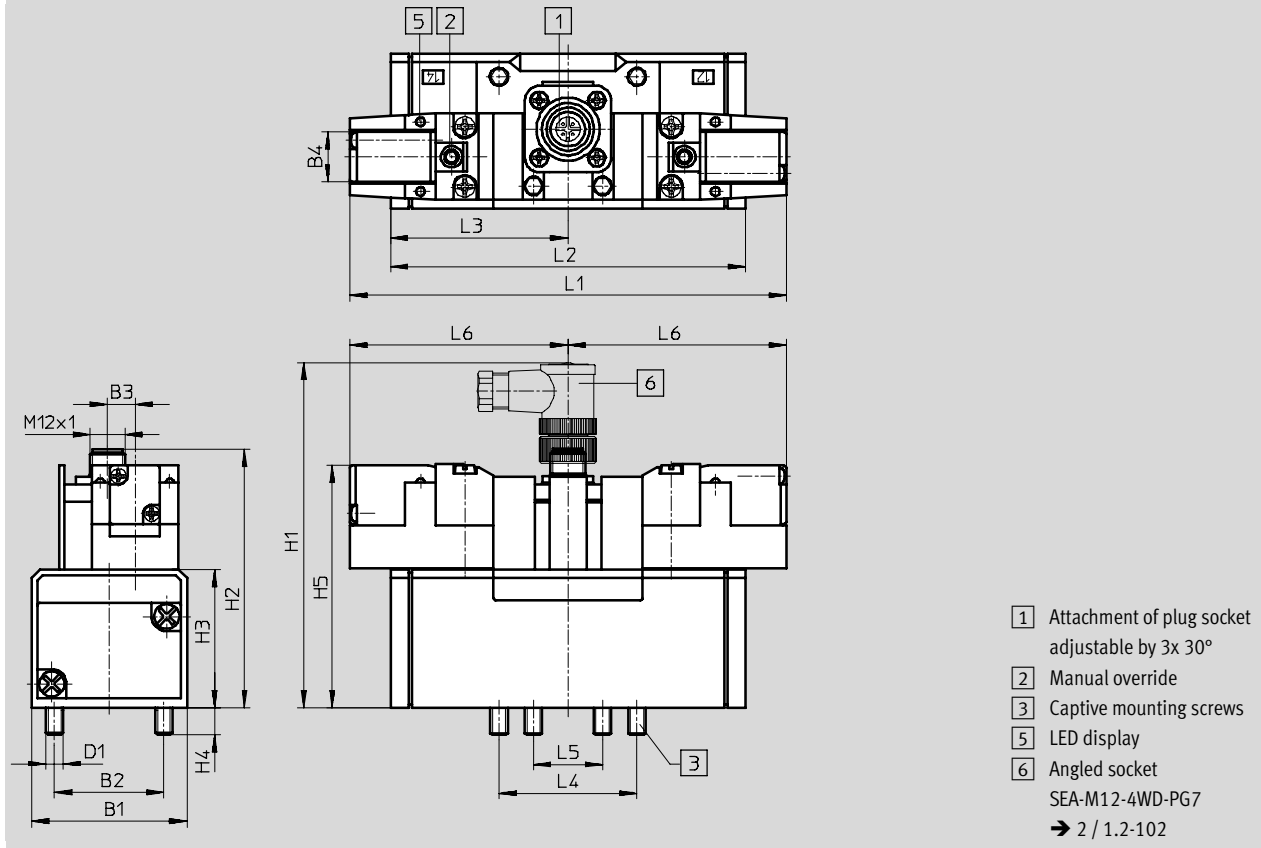

- 1 Attachment of plug socket adjustable by 3x 30°
- 2 Manual override
- 3 Captive mounting screws
- 5 LED display
- 6 Angled socket SEA-M12-4WD-PG7 → 2 / 1.2-102

ISO size	B1	B2	B3	B4	D1	H1	H2	H3	H4	H5	L1	L2	L3	L4	L5	L6
1	42	28	6	17.5	M5	110	80.3	38	9	74.7	134	87.6	43.8	36	18	67
2	54	38	9	17.5	M6	120	90.1	48	9.5	84.2	151.8	123.4	61.7	48	24	75.9
3	65	48	12	17.5	M8	130	97.8	55	12	93.1	171.9	145.4	72.7	64	32	86

M12 central plug – Terminal allocation

Duo connection

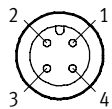

- 1 Unused
- 2 Signal (+) Solenoid 12
- 3 com (-)
- 4 Signal (+) Solenoid 14

Standard directional control valves
ISO 5599/1

1.2

Solenoid valves JMEBH, ISO 5599-1



Technical data – 5/2-way valves, double solenoid

Standard directional control valves
ISO 5599/1



1.2

Ordering data					
Circuit symbol	Solenoid coil	Voltage	ISO size	Part No.	Type
	With EB solenoid coil, with central plug, internal pilot air supply	24 V DC	1	184 495	JMEBH-5/2-D-1-ZSR-C
			2	184 502	JMEBH-5/2-D-2-ZSR-C
			3	184 509	JMEBH-5/2-D-3-ZSR-C
	With EB solenoid coil, with central plug, internal pilot air supply, with dominant signal at 14	24 V DC	1	184 496	JMEBDH-5/2-D-1-ZSR-C
			2	184 503	JMEBDH-5/2-D-2-ZSR-C
			3	184 510	JMEBDH-5/2-D-3-ZSR-C

Solenoid valves MEBH, ISO 5599-1

FESTO

Technical data – 5/3-way valves

-  - Flow rate
1200 ... 4600 l/min
-  - Voltage
24 V DC

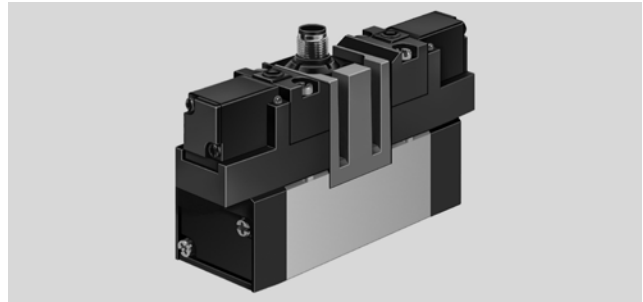

General technical data					
ISO size		1	2	3	
Valve function		5/3-way, single solenoid			
Constructional design		Piston spool			
Sealing principle		Soft			
Actuation type		Electrical			
Type of reset		Mechanical spring			
Type of pilot control		Piloted			
Pilot air supply		Internal			
Direction of flow		Non-reversible			
Exhaust function		With flow control			
Manual override		Via accessory, detenting			
Type of mounting		Via through-holes			
Mounting position		Any			
Nominal size		[mm]	8	11	14.5
Standard nominal flow rate	Closed	[l/min]	1200	2300	4100
	Exhausted	[l/min]			4600
	Pressurised	[l/min]			4000
Grid dimension		[mm]	43	56	71
Pneumatic connection on sub-base			G $\frac{1}{4}$	G $\frac{3}{8}$	G $\frac{1}{2}$
Product weight		[g]	630	800	1120
Noise level		[dB (A)]	85		

Operating and environmental conditions			
Operating medium		Filtered compressed air, lubricated or unlubricated Vacuum	
Operating pressure	Internal pilot air supply	[bar]	3 ... 10
	External pilot air supply	[bar]	-0.9 ... +16
Pilot pressure		[bar]	3 ... 10
Ambient temperature		[°C]	-5 ... +50
Temperature of medium		[°C]	-5 ... +50

Valve response times [ms]						
ISO size	1		2		3	
	On	Off	On	Off	On	Off
With EB solenoid coil						
	19	68	30	106	38	130

Standard directional control valves
ISO 5599/1
1.2

Solenoid valves MEBH, ISO 5599-1

Technical data – 5/3-way valves



Standard directional control valves
ISO 5599/1
1.2

Electrical data			
EB solenoid coil			
Electrical connection	Central plug, round design, M12x1		
Operating voltage	D.C. voltage	[V DC]	24
Coil characteristics	D.C. voltage	[W]	2.5
Protection class to EN 60 529			IP65

Materials

Sectional view

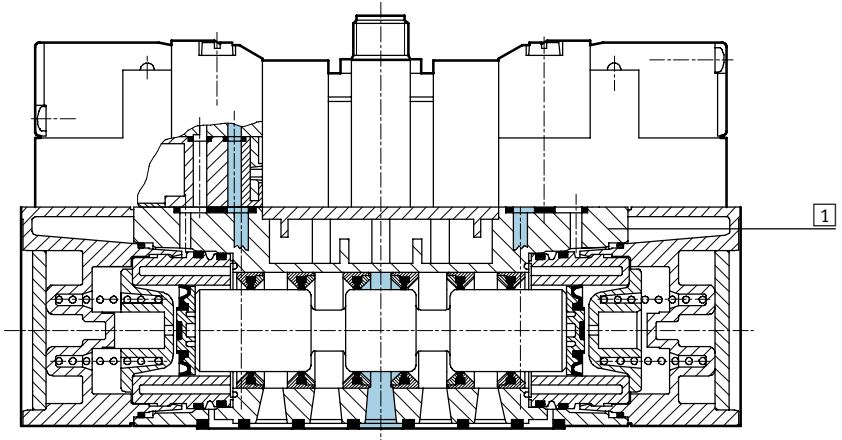

1	Housing	Die-cast aluminium, polyacetate
-	Seals	Nitrile rubber

Solenoid valves MEBH, ISO 5599-1

Technical data – 5/3-way valves

FESTO

Dimensions

Download CAD data → www.festo.com/en/engineering

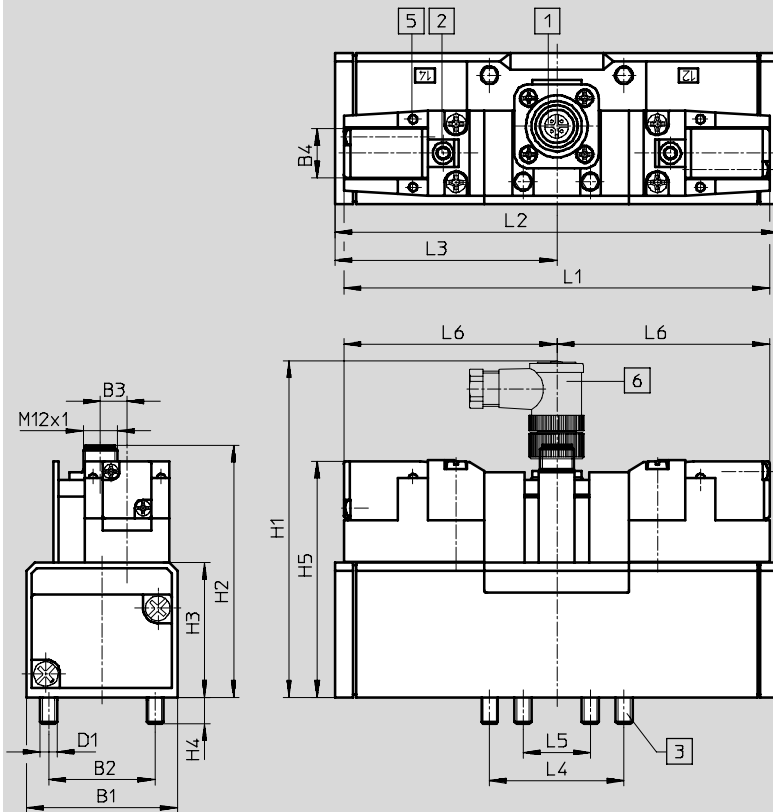

- 1 Attachment of plug socket adjustable by 3x 30°
- 2 Manual override
- 3 Captive mounting screws
- 4 LED display
- 5 Angled socket SEA-M12-4WD-PG7 → 2 / 1.2-102
- 6

ISO size	B1	B2	B3	B4	D1	H1	H2	H3	H4	H5	L1	L2	L3	L4	L5	L6
1	42	28	6	17.5	M5	110	80.3	38	9	74.7	134	108.4	54.2	36	18	67
2	54	38	9	17.5	M6	120	90.1	48	9.5	84.2	151.8	158	79	48	24	75.9
3	65	48	12	17.5	M8	130	97.8	55	12	93.1	171.9	184	92	64	32	86

M12 central plug – Terminal allocation

Duo connection

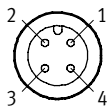

- 1 Unused
- 2 Signal (+) Solenoid 12
- 3 com (-)
- 4 Signal (+) Solenoid 14

Standard directional control valves
ISO 5599/1

1.2

Solenoid valves MEBH, ISO 5599-1

FESTO

Technical data – 5/3-way valves

Standard directional control valves
ISO 5599/1



1.2

Ordering data					
Circuit symbol	Description	Voltage	ISO size	Part No.	Type
	With EB solenoid coil, with central plug, normally closed, internal pilot air supply	24 V DC	1	184 498	MEBH-5/3G-D-1-ZSR-C
			2	184 505	MEBH-5/3G-D-2-ZSR-C
			3	184 512	MEBH-5/3G-D-3-ZSR-C
	With EB solenoid coil, with central plug, normally exhausted, internal pilot air supply	24 V DC	1	184 497	MEBH-5/3E-D-1-ZSR-C
			2	184 504	MEBH-5/3E-D-2-ZSR-C
			3	184 511	MEBH-5/3E-D-3-ZSR-C
	With EB solenoid coil, with central plug, normally pressurised, internal pilot air supply	24 V DC	1	184 499	MEBH-5/3B-D-1-ZSR-C
			2	184 506	MEBH-5/3B-D-2-ZSR-C
			3	184 513	MEBH-5/3B-D-3-ZSR-C

Solenoid valves MDH-M12, ISO 5599-1

FESTO

Technical data – 5/2-way valves

-  Flow rate
1,200 ... 4,500 l/min
-  Voltage
24 V DC



General technical data				
ISO size	1	2	3	
Valve function	5/2-way, monostable			
Design	Piston slide			
Sealing principle	Soft			
Actuation type	Electrical			
Type of reset	Mechanical or pneumatic spring			
Type of actuation	Piloted			
Pilot air supply	Internal or external			
Direction of flow	Reversible for external pilot air supply			
Exhaust function	Restrictable			
Manual override	Via tool accessory, detenting			
Type of mounting	Via through-holes			
Mounting position	Any			
Nominal size	[mm]	8	11	14.5
Standard nominal flow rate	[l/min]	1,200	2,300	4,500
Grid dimension	[mm]	43	56	71
Pneumatic connection on sub-base		G $\frac{3}{4}$	G $\frac{3}{8}$	G $\frac{1}{2}$
Product weight	[g]	420	810	1,000

Operating and environmental conditions			
Type of reset		pneumatic spring	mechanical spring
Operating medium		Dried compressed air, lubricated or unlubricated, grade of filtration 40µm Vacuum	
Operating pressure	internal pilot air supply [bar]	2 ... 10	3 ... 10
	external pilot air supply [bar]	-0.9 ... +16	
Pilot pressure	[bar]	2 ... 10	3 ... 10
Ambient temperature	[°C]	-10 ... +50	
Temperature of medium	[°C]	-10 ... +50	

Valve response times							
ISO size	1		2		3		
	pneumatic	mechanical	pneumatic	mechanical	pneumatic	mechanical	
D solenoid coil with M12x1 plug							
On	[ms]	25	20	45	25	55	30
Off	[ms]	36	42	60	60	60	70

Standard directional control valves
ISO 5599/1

1.2

Solenoid valves MDH-M12, ISO 5599-1

FESTO

Technical data – 5/2-way valves

Standard directional control valves
ISO 5599/1
1.2

Electrical data			
D solenoid coil with round plug M12x1			
Electrical connection	Type		M12X1
Coil characteristics	D.C. voltage	[V DC]	21.6...26.4
	Power	[Watt]	2.7
Duty cycle		%	100
Protection class to EN 60 529			IP65

Materials

Sectional view

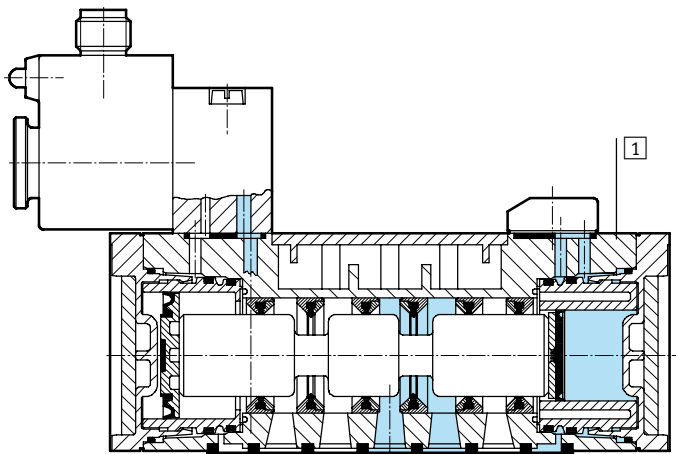

1	Body	Die-cast aluminium, polyacetate
-	Seals	Nitrile rubber

Solenoid valves MDH-M12, ISO 5599-1



Technical data – 5/2-way valves

Dimensions

Download CAD data → www.festo.com/en/engineering

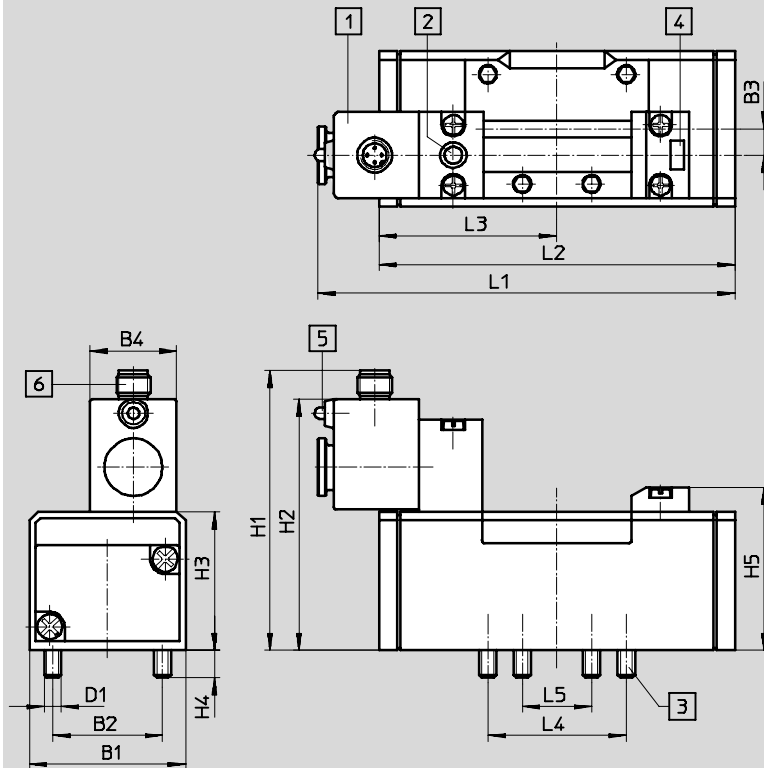

- 1 Solenoid coil can be repositioned by 90° regardless of manual override
- 2 Manual override facility
- 3 Captive mounting screws
- 4 Slot for inscription label
- 5 LED display
- 6 Plug socket M12x1
Coil 2-pin to VDMA
Coil 4-pin to Desina

Type	B1	B2	B3	B4	D1	H1	H2	H3	H4	H5	L1	L2	L3	L4	L5
ISO size 1															
MDH-5/2-...	42	28	6	30	M5	87.2	77.3	38	9	46.5	121.8	87.6	43.8	36	18
MDH-5/2-...-FR											132.2	98			
ISO size 2															
MDH-5/2-...	54	38	9	30	M6	97.2	87.2	48	9.5	56.5	144.6	123.4	61.7	48	24
MDH-5/2-...-FR											161.9	140.6			
ISO size 3															
MDH-5/2-...	65	48	12	30	M8	104.2	94.2	55	12	62.7	165.9	145.4	72.7	64	32
MDH-5/2-...-FR											185.2	164.7			

M12 plug – Pin allocation 2-pin to VDMA

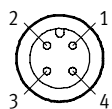

- 1 Unused
- 2 Unused
- 3 com (-)
- 4 Signal (+)

M12 plug – Pin allocation 4-pin to Desina

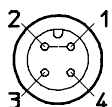

- 1 connected with 2
- 2 connected with 1
- 3 com (-)
- 4 Signal (+)

Solenoid valves MDH-M12, ISO 5599-1

FESTO

Technical data – 5/2-way valves

Standard directional control valves
ISO 5599/1



1.2

Ordering data						
Circuit symbol	Description	ISO size	Coil 2-pin to VDMA		Coil 4-pin to Desina	
			Part No.	Type	Part No.	Type
	Type of reset: – pneumatic Pilot air supply: – internal	1	197 125	MDH-5/2-D-1-M12-C	540 803	MDH-5/2-D-1-M12D-C
		2	533 008	MDH-5/2-D-2-M12-C	540 812	MDH-5/2-D-2-M12D-C
		3	533 009	MDH-5/2-D-3-M12-C	540 819	MDH-5/2-D-3-M12D-C
	Type of reset: – pneumatic Pilot air supply: – external	1	533 332	MDH-5/2-D-1-S-M12-C	540 810	MDH-5/2-D-1-S-M12D-C
	Type of reset: – mechanical Pilot air supply: – internal	1	533 010	MDH-5/2-D-1-FR-M12-C	540 804	MDH-5/2-D-1-FR-M12D-C
		2	533 011	MDH-5/2-D-2-FR-M12-C	540 813	MDH-5/2-D-2-FR-M12D-C
		3	533 012	MDH-5/2-D-3-FR-M12-C	540 820	MDH-5/2-D-3-FR-M12D-C
	Type of reset: – mechanical Pilot air supply: – external	1	533 761	MDH-5/2-D-1S-FR-M12-C	540 811	MDH-5/2-D-1S-FR-M12D-C

Solenoid valves JMDH-M12, ISO 5599-1

FESTO

Technical data – 5/2-way valves, double solenoid

-  - Flow rate
1,200 ... 4,500 l/min
-  - Voltage
12, 24, 42, 48 V DC
24, 42, 48, 110, 230,
240 V AC



General technical data				
ISO size	1	2	3	
Valve function	5/2-way, bistable			
Design	Piston spool			
Sealing principle	Soft			
Actuation type	Electrical			
Type of actuation	Piloted			
Pilot air supply	Internal			
Direction of flow	Non-reversible			
Exhaust function	Restrictable			
Manual override	Via tool accessory, detenting			
Type of mounting	Via through-holes			
Mounting position	Any			
Nominal size	[mm]	8	11	14.5
Standard nominal flow rate	[l/min]	1,200	2,300	4,000
Grid dimension	[mm]	43	56	71
Pneumatic connection on sub-base		G $\frac{1}{4}$	G $\frac{3}{8}$	G $\frac{1}{2}$
Product weight	[g]	550	810	1,100

Operating and environmental conditions			
Operating medium	Filtered compressed air, lubricated or unlubricated, grade of filtration 40µm		
Operating pressure	internal pilot air supply	[bar]	2 ... 10
Ambient temperature		[°C]	-10... +50
Temperature of medium		[°C]	-10 ... +50

Valve response times				
ISO size	1	2	3	
D solenoid coil with round plug M12x1				
	[ms]	18	22	25

Standard directional control valves
ISO 5599/1

1.2

Solenoid valves JMDH-M12, ISO 5599-1

FESTO

Technical data – 5/2-way valves, double solenoid

Electrical data			
D solenoid coil with round plug			
Electrical connection	Type		M12X1
Coil characteristics	D.C. voltage	[V DC]	21.6...26.4
	Power	[Watt]	2.7
Duty cycle		%	100
Protection class to EN 60 529			IP65

Materials

Sectional view

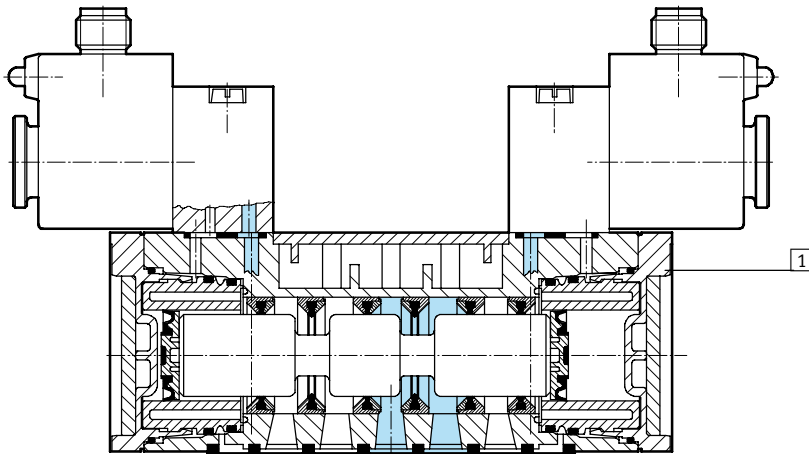

1	Body	Die-cast aluminium, polyacetate
-	Seals	Nitrile rubber

Solenoid valves JMDH-M12, ISO 5599-1



Technical data – 5/2-way valves, double solenoid

Dimensions

Download CAD data → www.festo.com/en/engineering

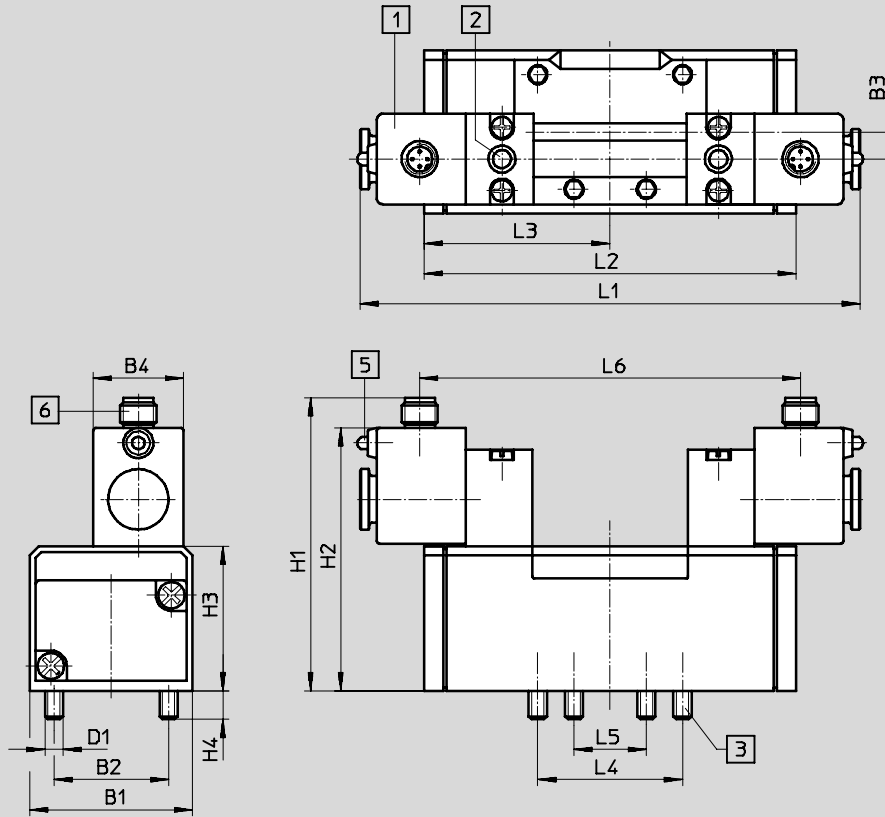

- 1 Solenoid coil can be repositioned by 90° regardless of manual override
- 2 Manual override facility
- 3 Captive mounting screws
- 5 LED display
- 6 Plug socket M12x1
Coil 2-pin to VDMA
Coil 4-pin to Desina

ISO size	B1	B2	B3	B4	D1	H1	H2	H3	H4	L1	L2	L3	L4	L5	L6
1	42	28	6	30	M5	87.2	77.2	38	9	148	87.6	43.8	36	18	108.5
2	54	38	9	30	M6	97.2	87.2	48	9.5	165.8	123.4	61.7	48	24	126.3
3	65	48	12	30	M8	104.2	94.2	55	12	186.4	145.4	72.7	64	32	146.9

M12 plug – Pin allocation 2-pin to VDMA

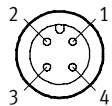

- 1 Unused
- 2 Unused
- 3 com (-)
- 4 Signal (+)

M12 plug – Pin allocation 4-pin to Desina

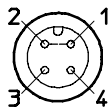

- 1 connected with 2
- 2 connected with 1
- 3 com (-)
- 4 Signal (+)

Solenoid valves JMDH-M12, ISO 5599-1

FESTO

Technical data – 5/2-way valves, double solenoid

Standard directional control valves
ISO 5599/1



1.2

Ordering data						
Circuit symbol	Description	ISO size	Coil 2-pin to VDMA		Coil 4-pin to Desina	
			Part No.	Type	Part No.	Type
	Pilot air supply: – internal	1	532 687	JMDH-5/2-D-1-M12-C	540 809	JMDH-5/2-D-1-M12D-C
		2	533 013	JMDH-5/2-D-2-M12-C	540 818	JMDH-5/2-D-2-M12D-C
		3	533 015	JMDH-5/2-D-3-M12-C	540 825	JMDH-5/2-D-3-M12D-C
	Pilot air supply: – internal Dominant: – signal at 14	1	539 079	JMDDH-5/2-D-1-M12-C	540 808	JMDDH-5/2-D-1-M12D-C
		2	539 077	JMDDH-5/2-D-2-M12-C	540 817	JMDDH-5/2-D-2-M12D-C
		3	539 081	JMDDH-5/2-D-3-M12-C	540 824	JMDDH-5/2-D-3-M12D-C

Solenoid valves MDH-M12, ISO 5599-1

FESTO

Technical data – 5/3-way valves

-  - Flow rate
1,200 ... 4,600 l/min
-  - Voltage
24 V DC

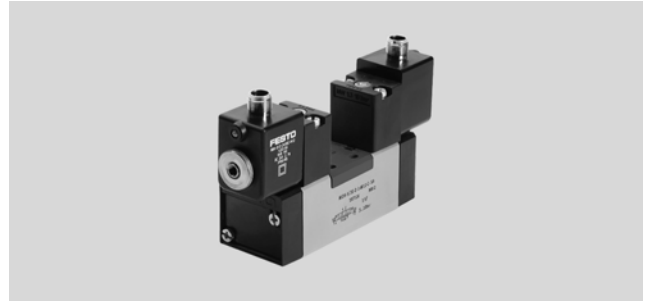

General technical data				
ISO size	1	2	3	
Valve function	5/3-way, monostable			
Design	Piston spool			
Sealing principle	Soft			
Actuation type	Electrical			
Type of reset	Mechanical spring			
Type of actuation	Piloted			
Pilot air supply	Internal			
Direction of flow	Non-reversible			
Exhaust function	Restrictable			
Manual override	Via tool accessory, detenting			
Type of mounting	Via through-holes			
Mounting position	Any			
Nominal size	[mm]	8	11	14.5
Standard nominal flow rate	[l/min]	1,200	2,300	4,000 (B), 4,100 (G), 4,600 (E)
Grid dimension	[mm]	43	56	71
Pneumatic connection on sub-base		G $\frac{1}{4}$	G $\frac{3}{8}$	G $\frac{1}{2}$
Product weight	[g]	580	880	1,120

Operating and environmental conditions			
Operating medium	Filtered compressed air, lubricated or unlubricated, grade of filtration 40µm		
Operating pressure	internal pilot air supply	[bar]	3 ... 10
Ambient temperature		[°C]	-10 ... +50
Temperature of medium		[°C]	-10 ... +50

Valve response times							
ISO size	1		2		3		
	On	Off	On	Off	On	Off	
with D solenoid coil with round plug M12x1							
	[ms]	25	55	35	70	36	90

Standard directional control valves
ISO 5599/1

1.2

Solenoid valves MDH-M12, ISO 5599-1

FESTO

Technical data – 5/3-way valves

Standard directional control valves
ISO 5599/1
1.2

Electrical data			
D solenoid coil with round plug			
Electrical connection	Type		M12X1
Coil characteristics	D.C. voltage	[V DC]	21.6...26.4
	Power	[Watt]	2.7
Duty cycle		%	100
Protection class to EN 60 529			IP65

Materials

Sectional view

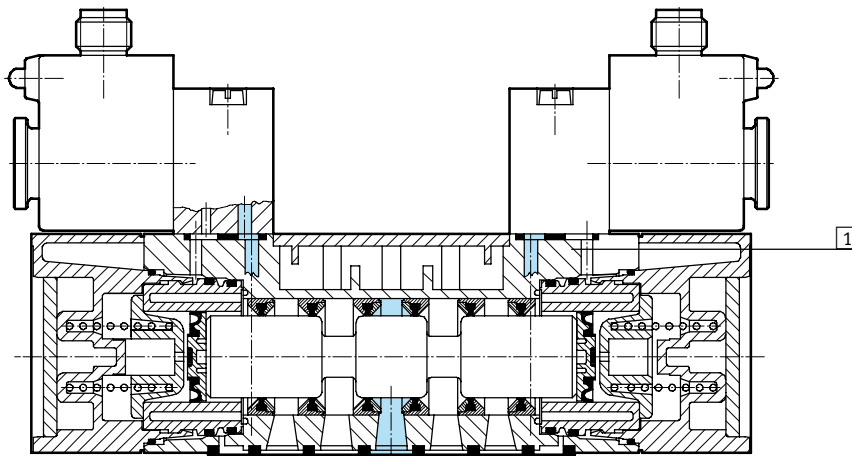

1	Body	Die-cast aluminium, polyacetate
-	Seals	Nitrile rubber

Solenoid valves MDH-M12, ISO 5599-1



Technical data – 5/3-way valves

Dimensions

Download CAD data → www.festo.com/en/engineering

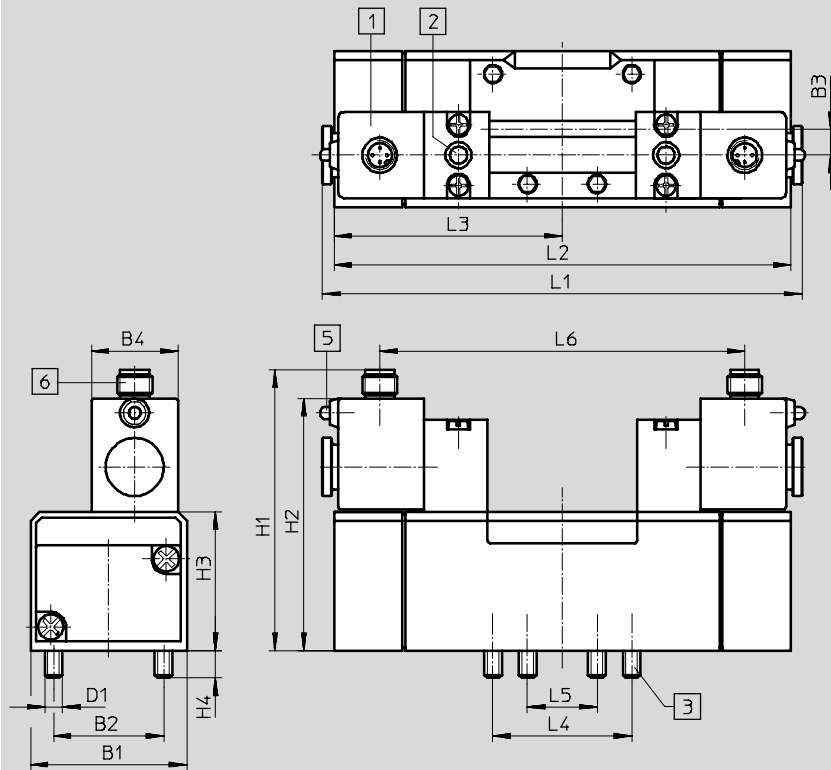

- 1 Solenoid coil can be repositioned by 90° regardless of manual override
- 2 Manual override facility
- 3 Captive mounting screws
- 5 LED display
- 6 Plug socket M12x1
Coil 2-pin to VDMA
Coil 4-pin to Desina

ISO size	B1	B2	B3	B4	D1	H1	H2	H3	H4	L1	L2	L3	L4	L5	L6
1	42	28	6	30	M5	87.2	77.2	38	9	148	108.4	54.3	36	18	108.5
2	54	38	9	30	M6	97.2	87.2	48	9.5	165.8	158	79	48	24	126.3
3	65	48	12	30	M8	104.2	94.2	55	12	186.4	184	92	64	32	146.9

M12 plug – Pin allocation 2-pin to VDMA

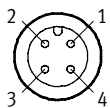

- 1 Unused
- 2 Unused
- 3 com (-)
- 4 Signal (+)

M12 plug – Pin allocation 4-pin to Desina

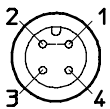

- 1 connected with 2
- 2 connected with 1
- 3 com (-)
- 4 Signal (+)

Solenoid valves MDH-M12, ISO 5599-1

FESTO

Technical data – 5/3-way valves

Standard directional control valves
ISO 5599/1



1.2

Ordering data						
Circuit symbol	Description	ISO size	Coil 2-pin to VDMA		Coil 4-pin to Desina	
			Part No.	Type	Part No.	Type
	Normal position: – closed Pilot air supply: – internal	1	525 307	MDH-5/3G-D-1-M12-C	540 806	MDH-5/3G-D-1-M12D-C
		2	539078	MDH-5/3G-D-2-M12-C	540 815	MDH-5/3G-D-2-M12D-C
		3	539080	MDH-5/3G-D-3-M12-C	540 822	MDH-5/3G-D-3-M12D-C
	Normal position: – exhausted Pilot air supply: – internal	1	197 126	MDH-5/3E-D-1-M12-C	540 805	MDH-5/3E-D-1-M12D-C
		2	533 016	MDH-5/3E-D-2-M12-C	540 814	MDH-5/3E-D-2-M12D-C
		3	533 017	MDH-5/3E-D-3-M12-C	540 821	MDH-5/3E-D-3-M12D-C
	Normal position: – pressurised Pilot air supply: – internal	1	533 005	MDH-5/3B-D-1-M12-C	540 807	MDH-5/3B-D-1-M12D-C
		2	533 006	MDH-5/3B-D-2-M12-C	540 816	MDH-5/3B-D-2-M12D-C
		3	533 007	MDH-5/3B-D-3-M12-C	540 823	MDH-5/3B-D-3-M12D-C

Solenoid valves MDH, ISO 5599-1

FESTO

Technical data – 5/2-way valves

-  - Flow rate
-  - Voltage
24 V DC
42, 110, 230 V AC



General technical data		
ISO size	4	
Valve function	5/2-way, single solenoid	
Constructional design	Piston spool	
Sealing principle	Soft	
Actuation type	Electrical	
Type of reset	Pneumatic spring	
Type of pilot control	Piloted	
Pilot air supply	Internal	
Direction of flow	Non-reversible	
Exhaust function	With flow control	
Manual override	Via accessory, detenting	
Type of mounting	Via through-holes	
Mounting position	Any	
Nominal size	[mm]	18
Standard nominal flow rate	[l/min]	6000
Grid dimension	[mm]	82
Pneumatic connection on sub-base	G3/4	
Product weight	[g]	2600

Operating and environmental conditions			
Operating medium	Filtered compressed air, lubricated or unlubricated		
Operating pressure	Internal pilot air supply	[bar]	3 ... 16
	External pilot air supply	[bar]	-
Pilot pressure		[bar]	-
Ambient temperature		[°C]	-5 ... +40
Temperature of medium		[°C]	-10 ... +60

Valve response times [ms]	
D solenoid coil	
On	120
Off	160

Standard directional control valves
ISO 5599/1

1.2

Solenoid valves MDH, ISO 5599-1

FESTO

Technical data – 5/2-way valves

Standard directional control valves
ISO 5599/1
1.2

Electrical data			
D solenoid coil			
Electrical connection	Design		Plug, square design to EN 175301-803, type A
Operating voltage	D.C. voltage	[V DC]	24
	A.C. voltage	[V AC]	42, 110, 230 (50 ... 60 Hz)
Coil characteristics	D.C. voltage	[W]	6.8
	A.C. voltage	[VA]	Pull: 16.5
	42 V		Hold: 12.2
	A.C. voltage 110 V, 230 V	[VA]	Pull: 14.4
			Hold: 10.5
Protection class to EN 60 529			IP65

Materials

Sectional view

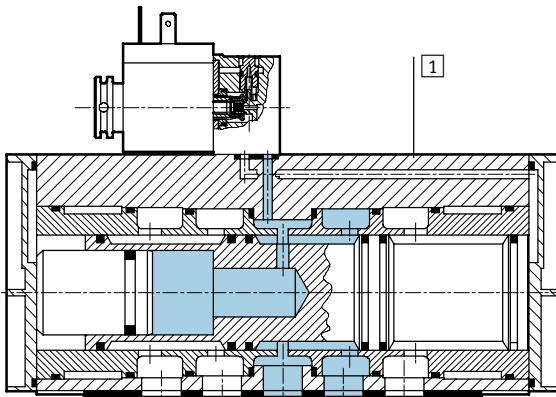

1	Housing	Anodised aluminium, polyacetate, brass
-	Seals	Nitrile rubber, polyurethane, polytetrafluoroethylene carbon

Solenoid valves MDH, ISO 5599-1

Technical data – 5/2-way valves

FESTO

Dimensions

Download CAD data → www.festo.com/en/engineering

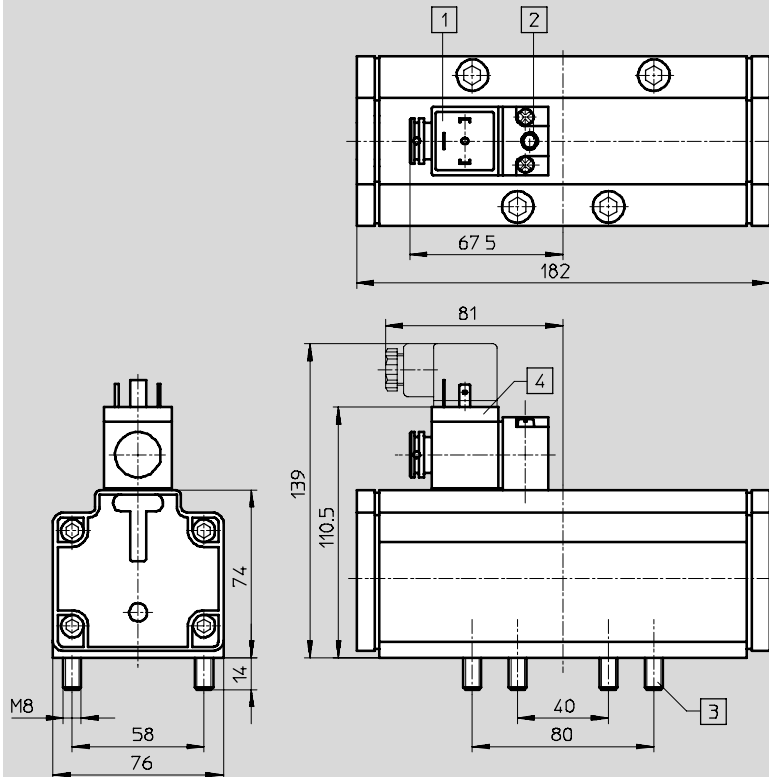

- 1 Wiring at plug socket to EN 175301-803, type A → 2 / 1.2-101
- 2 Manual override
- 3 Captive mounting screws
- 4 Solenoid coil can be repositioned by 90° regardless of manual override

Standard directional control valves
ISO 5599/1

1.2

Ordering data



Circuit symbol	Solenoid coil	Voltage	ISO size	Part No.	Type	
	With D solenoid coil, pneumatic reset, internal pilot air supply	24 V DC	4	12 457	MDH-5/2-3/4-D-4-24DC	
		–		14 544	MDH-5/2-3/4-D-4 ¹⁾	
	Usable pilot valves:					
	24 V DC	–	119 600	MDH-3/2-24DC		
	110 V AC	–	119 601	MDH-3/2-110AC		
	230 V AC	–	119 602	MDH-3/2-230AC		
	24 V DC/ 42 V AC	–	119 603	MDH-3/2-24DC/42AC		

1) Without pilot valve. The part number for the pilot valve must be quoted when ordering.
Order example: 14 544 MDH-5/2-3/4-D-4-119 602

Solenoid valves JMDH, ISO 5599-1

Technical data – 5/2-way valves, double solenoid

FESTO

-  - Flow rate
6000 l/min
-  - Voltage
24 V DC
42, 110, 230 V AC



Standard directional control valves
ISO 5599/1

1.2

General technical data	
ISO size	4
Valve function	5/2-way, double solenoid
Constructional design	Piston spool
Sealing principle	Soft
Actuation type	Electrical
Type of pilot control	Piloted
Pilot air supply	Internal
Direction of flow	Non-reversible
Exhaust function	With flow control
Manual override	Via accessory, detenting
Type of mounting	Via through-holes
Mounting position	Any
Nominal size	[mm] 18
Standard nominal flow rate	[l/min] 6000
Grid dimension	[mm] 82
Pneumatic connection on sub-base	G3/4
Product weight	[g] 2600

Operating and environmental conditions			
Operating medium	Filtered compressed air, lubricated or unlubricated		
Operating pressure	Internal pilot air supply	[bar]	2 ... 16
	External pilot air supply	[bar]	-
Pilot pressure		[bar]	-
Ambient temperature		[°C]	-5 ... +40
Temperature of medium		[°C]	-10 ... +60

Valve response times [ms]
With D solenoid coil
40

Solenoid valves JMDH, ISO 5599-1

FESTO

Technical data – 5/2-way valves, double solenoid

Electrical data			
D solenoid coil			
Electrical connection			Plug, square design to EN 175301-803, type A
Operating voltage	D.C. voltage	[V DC]	24
	A.C. voltage	[V AC]	42, 110, 230 (50 ... 60 Hz)
Coil characteristics	D.C. voltage	[W]	6.8
	A.C. voltage	[VA]	Pull: 16.5
	42 V		Hold: 12.2
	A.C. voltage 110 V, 230 V	[VA]	Pull: 14.5
			Hold: 10.5
Protection class to EN 60 529			IP65

Materials

Sectional view

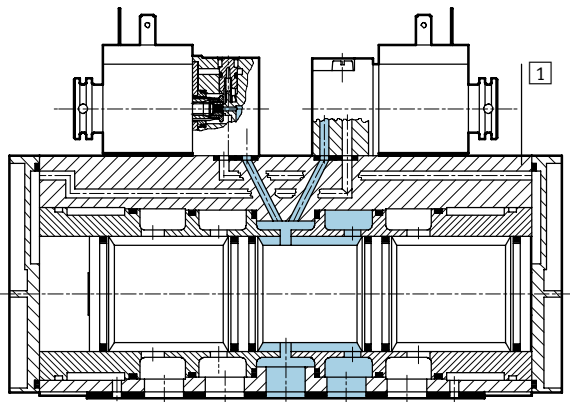

1	Housing	Anodised aluminium, polyacetate, brass
-	Seals	Nitrile rubber, polyurethane, polytetrafluoroethylene carbon

Standard directional control valves
ISO 5599/1

1.2

Solenoid valves JMDH, ISO 5599-1

Technical data – 5/2-way valves, double solenoid



Standard directional control valves
ISO 5599/1
1.2

Dimensions

Download CAD data → www.festo.com/en/engineering

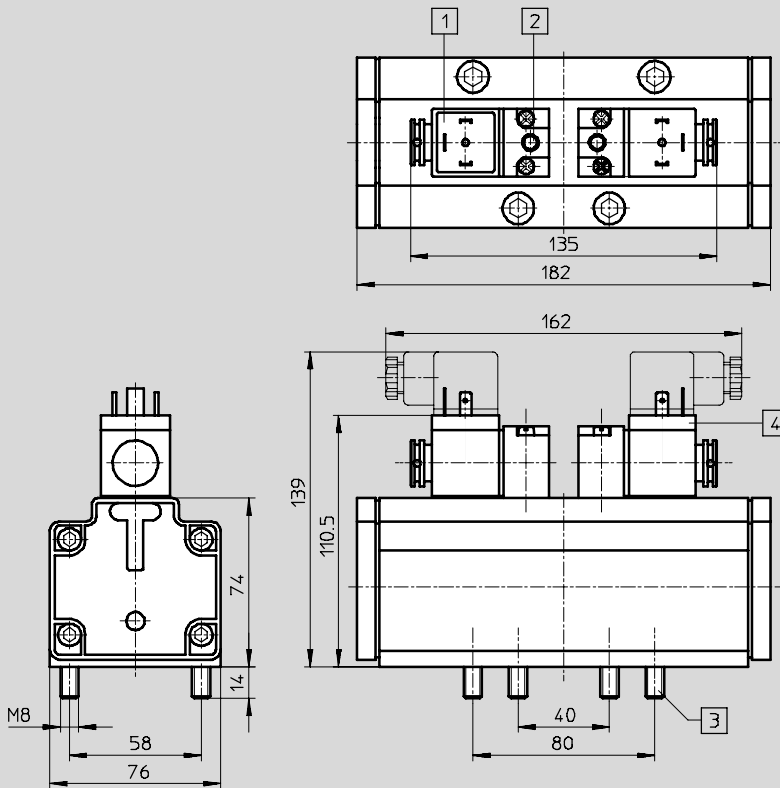

- 1 Wiring at plug socket to EN 175301-803, type A → 2 / 1.2-101
- 2 Manual override
- 3 Captive mounting screws
- 4 Solenoid coil can be repositioned by 90° regardless of manual override

Ordering data – Double solenoid valve

Circuit symbol	Description	Voltage	ISO size	Part No.	Type
	With D solenoid coil, internal pilot air supply	24 V DC	4	12 458	JMDH-5/2-3/4-D-4-24DC
		–		14 545	JMDH-5/2-3/4-D-4¹⁾
Usable pilot valves:					
		24 V DC	–	119 600	MDH-3/2-24DC
		110 V AC	–	119 601	MDH-3/2-110AC
		230 V AC	–	119 602	MDH-3/2-230AC
		24 V DC/ 42 V AC	–	119 603	MDH-3/2-24DC/42AC

1) Without pilot valve. The part number for the pilot valve must be quoted when ordering.
Order example: 14 545 MDH-5/2-3/4-D-4-119 602

Solenoid valves MDH, ISO 5599-1

FESTO

Technical data – 5/3-way valves

-  - Flow rate
4800 l/min

-  - Voltage
24 V DC
42, 110, 230 V AC



General technical data			
ISO size	4		
Valve function	5/3-way, single solenoid		
Constructional design	Piston spool		
Sealing principle	Soft		
Actuation type	Electrical		
Type of reset	Pneumatic spring		
Type of pilot control	Piloted		
Pilot air supply	Internal		
Direction of flow	Non-reversible		
Exhaust function	With flow control		
Manual override	Via accessory, detenting		
Type of mounting	Via through-holes		
Mounting position	Any		
Nominal size	[mm]	18	
Standard nominal flow rate	Closed	[l/min]	4800
	Exhausted	[l/min]	4800
Grid dimension	[mm]	82	
Pneumatic connection on sub-base	G3/4		
Product weight	[g]	2600	

Operating and environmental conditions			
Operating medium	Filtered compressed air, lubricated or unlubricated		
Operating pressure	Internal pilot air supply	[bar]	3 ... 16
	External pilot air supply	[bar]	–
Pilot pressure		[bar]	–
Ambient temperature		[°C]	– 5 ... +40
Temperature of medium		[°C]	–10 ... +60

Valve response times [ms]	
With D solenoid coil	
On	85
Off	290

Standard directional control valves
ISO 5599/1
1.2

Solenoid valves MDH, ISO 5599-1

FESTO

Technical data – 5/3-way valves

Standard directional control valves
ISO 5599/1
1.2

Electrical data			
D solenoid coil			
Electrical connection		Plug, square design to EN 175301-803, type A	
Operating voltage	D.C. voltage	[V DC]	24
	A.C. voltage	[V AC]	42, 110, 230 (50 ... 60 Hz)
Coil characteristics	D.C. voltage	[W]	6.8
	A.C. voltage	[VA]	Pull: 16.5 Hold: 12.2
	42 V A.C. voltage 110 V, 230 V	[VA]	Pull: 14.5 Hold: 10.5

Materials

Sectional view

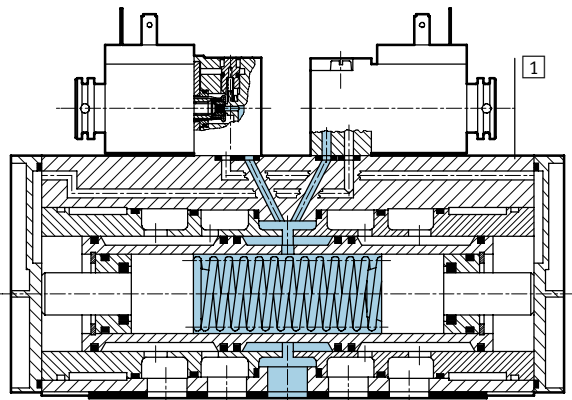

1	Housing	Anodised aluminium, polyacetate, brass
-	Seals	Nitrile rubber, polyurethane, polytetrafluoroethylene carbon

Solenoid valves MDH, ISO 5599-1

Technical data – 5/3-way valves

FESTO

Dimensions

Download CAD data → www.festo.com/en/engineering

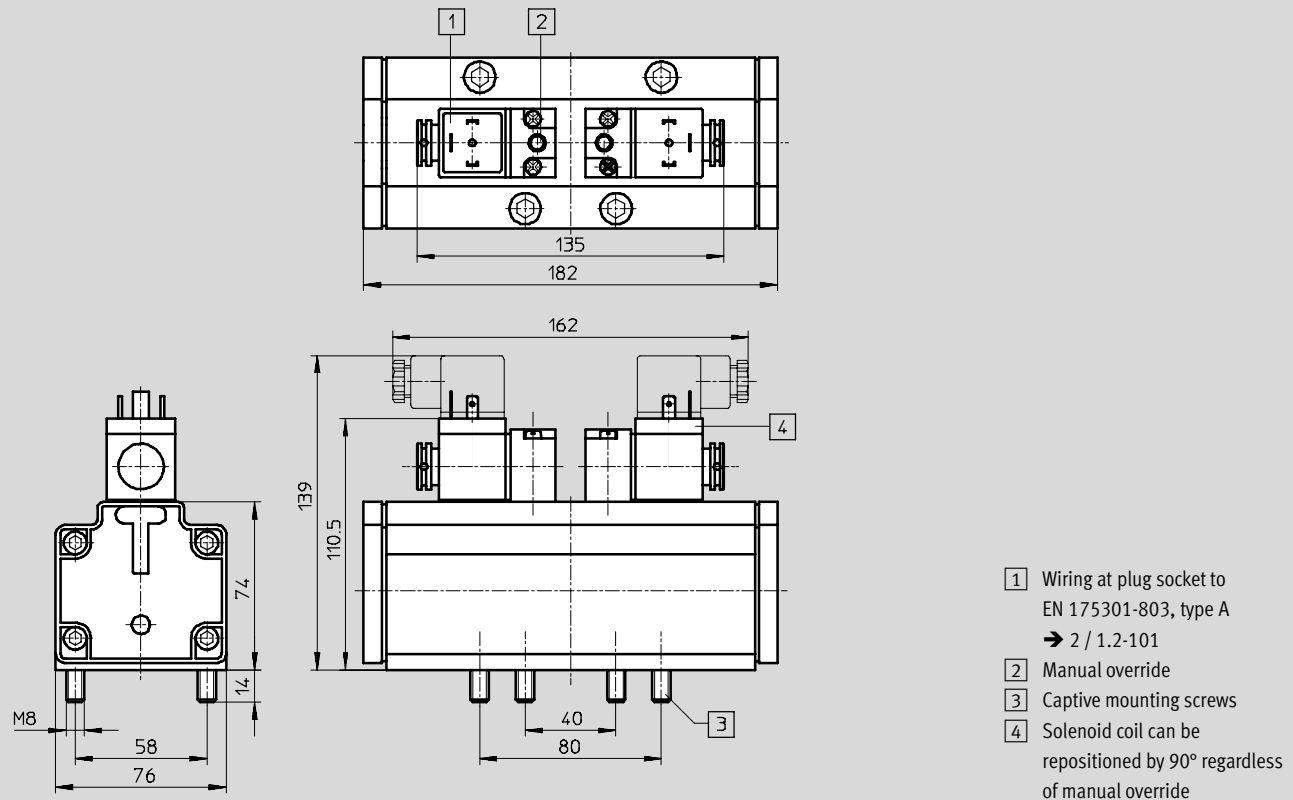

- 1 Wiring at plug socket to EN 175301-803, type A → 2 / 1.2-101
- 2 Manual override
- 3 Captive mounting screws
- 4 Solenoid coil can be repositioned by 90° regardless of manual override

Standard directional control valves
ISO 5599/1

1.2

Ordering data

Circuit symbol	Description	Voltage	ISO size	Part No.	Type		
	With D solenoid coil, normally closed, internal pilot air supply	24 V DC	4	12 459	MDH-5/3G-3/4-D-4-24DC		
		–		14 546	MDH-5/3G-3/4-D-4 ¹⁾		
		Usable pilot valves:					
		24 V DC	–	119 600	MDH-3/2-24DC		
		110 V AC	–	119 601	MDH-3/2-110AC		
230 V AC	–	119 602	MDH-3/2-230AC				
24 V DC/ 42 V AC	–	119 603	MDH-3/2-24DC/42AC				
	With D solenoid coil, normally exhausted, internal pilot air supply	24 V DC	4	12 460	MDH-5/3E-3/4-D-4-24DC		
		–		14 547	MDH-5/3E-3/4-D-4 ¹⁾		
		Usable pilot valves:					
		24 V DC	–	119 600	MDH-3/2-24DC		
		110 V AC	–	119 601	MDH-3/2-110AC		
230 V AC	–	119 602	MDH-3/2-230AC				
24 V DC/ 42 V AC	–	119 603	MDH-3/2-24DC/42AC				

1) Without pilot valve. The part number for the pilot valve must be quoted when ordering.
Order example: 14 546 MDH-5/3G-3/4-D-4-119 602

Pneumatic valves, ISO 5599-1

Type code

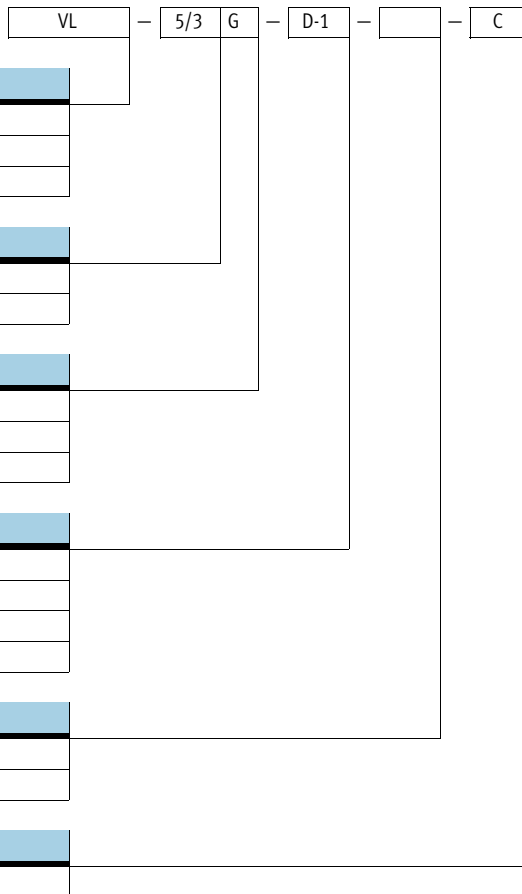

Pneumatic valves, ISO 5599-1

Peripherals overview

FESTO

Individual mounting

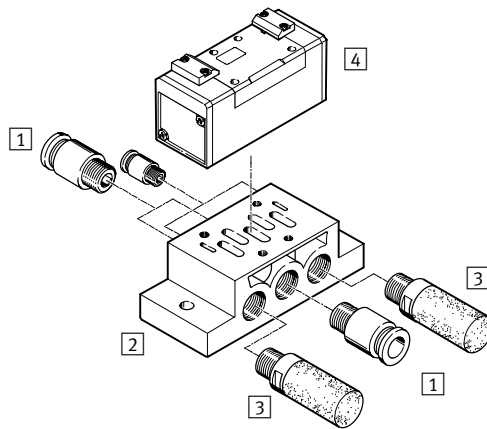

Variants

J-5/...-3/4-D-4,
VL-5/...-3/4-D-4

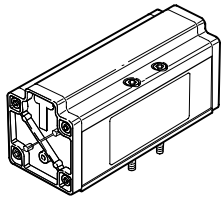

Accessories

	Brief description	→ Page
1	Push-in fitting QS	Volume 3
2	Individual sub-base NAS/NAU	2 / 1.2-88
3	Silencer	Volume 3
4	Pneumatic valve	2 / 1.2-6

Port pattern on sub-base to ISO 5599-1

Defined interfaces between valve and sub-base

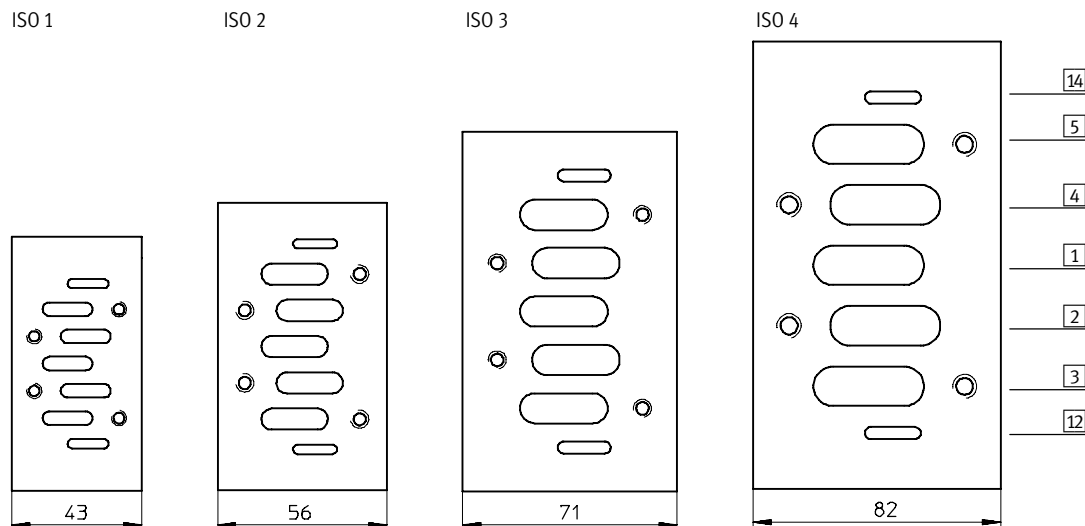

Pneumatic valves, ISO 5599-1

Peripherals overview

FESTO

Manifold mounting

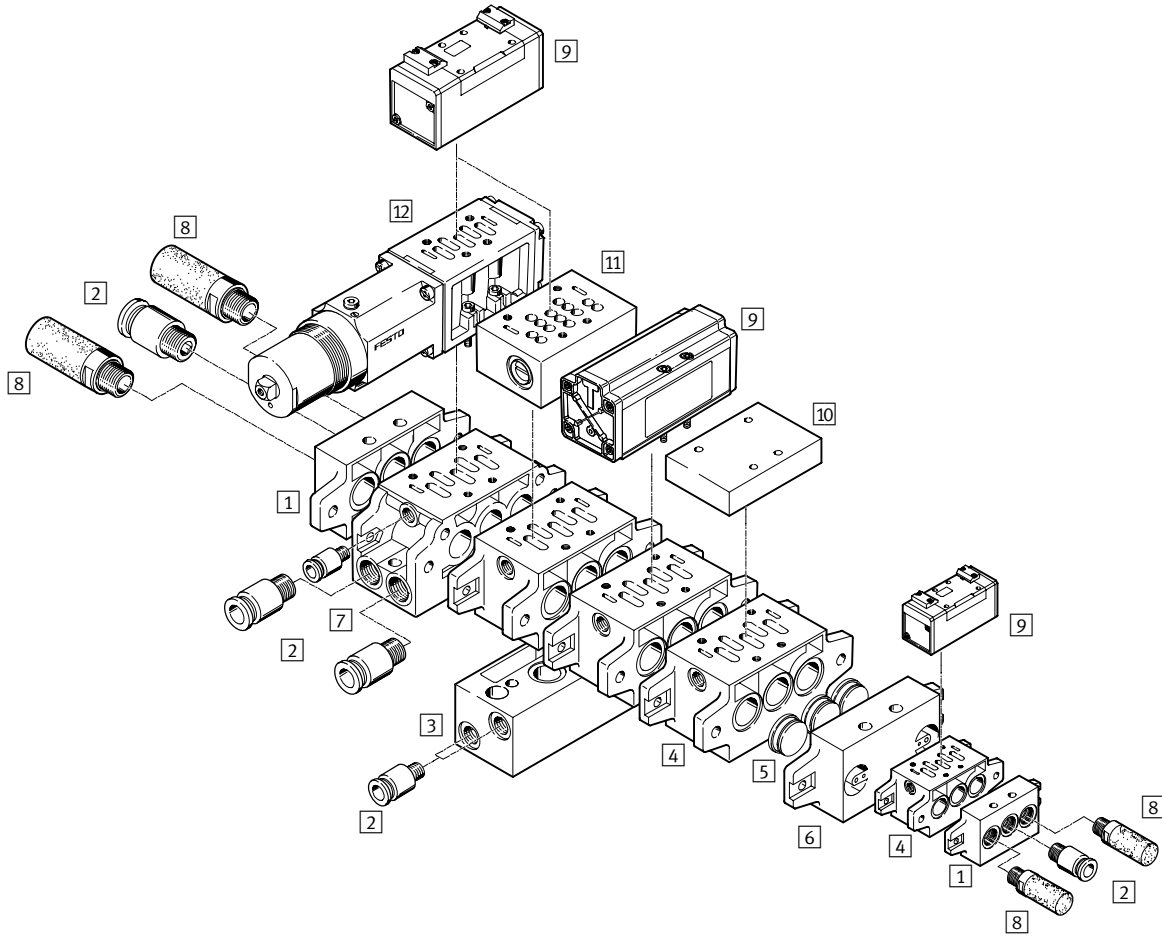

Standard directional control valves
ISO 5599/1

1.2

Pneumatic valves, ISO 5599-1

Peripherals overview

Accessories		
	Brief description	→ Page
1	End plate kit NEV	2 / 1.2-91
2	Push-in fitting QS	Volume 3
3	Angle connection block NAW	2 / 1.2-90
4	Manifold sub-base NAV	2 / 1.2-90
5	Isolating disc NSC	2 / 1.2-92
6	Intermediate plate NZV	2 / 1.2-94
7	Manifold sub-base for angle connection NAWW	2 / 1.2-91
8	Silencer	Volume 3
9	Pneumatic valve	Port pattern to ISO 5599-1
10	Blanking plate NDV	2 / 1.2-92
11	Throttle plate for ISO size 1, 2 and 3 GRO	2 / 1.2-95
12	Intermediate pressure regulator plate for ISO size 1, 2 and 3 LR-ZP	2 / 1.2-96

Port pattern on sub-base to ISO 5599-1

Defined interfaces between valve and sub-base

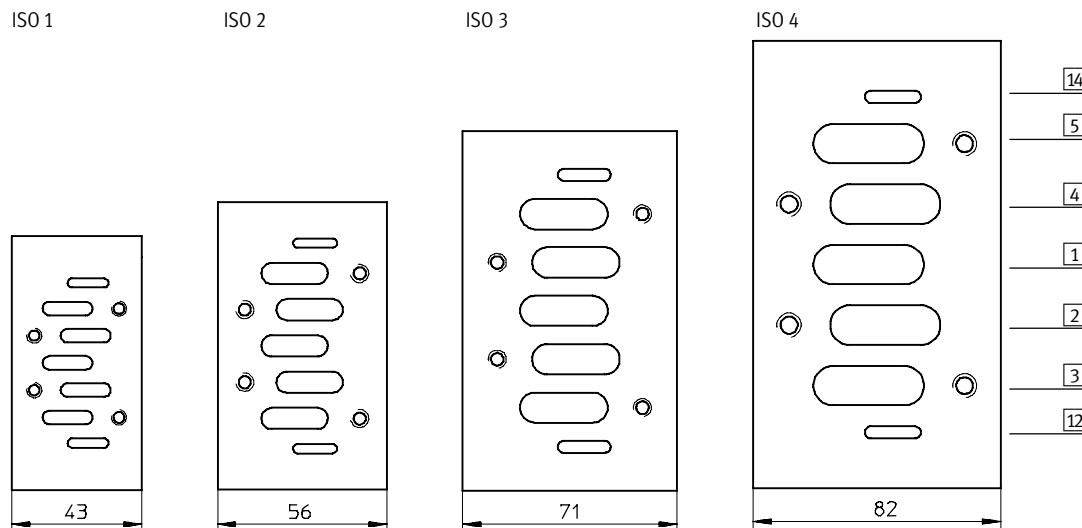

Pneumatic valves VL, ISO 5599-1

Technical data – 5/2-way valves

FESTO

-  - Flow rate
1200 ... 6000 l/min

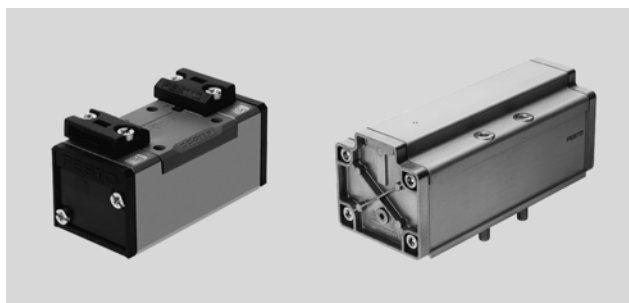

Standard directional control valves
ISO 5599/1

1.2

General technical data					
ISO size	1	2	3	4	
Valve function	5/2-way, single pilot				
Constructional design	Piston spool				
Sealing principle	Soft				
Actuation type	Pneumatic				
Type of reset	Mechanical or pneumatic spring				
Type of pilot control	Direct				
Direction of flow	Non-reversible				
Exhaust function	With flow control				
Manual override	None				
Type of mounting	Via through-holes				
Mounting position	Any				
Nominal size	[mm]	8	11	14.5	18
Standard nominal flow rate	[l/min]	1200	2300	4500	6000
Grid dimension	[mm]	43	56	71	82
Pneumatic connection on sub-base	1, 2, 3, 4, 5	G $\frac{1}{4}$	G $\frac{3}{8}$	G $\frac{1}{2}$	G $\frac{3}{4}$
	12, 14	G $\frac{1}{8}$	G $\frac{1}{8}$	G $\frac{1}{8}$	G $\frac{1}{8}$
Product weight	[g]	290	550	810	1800
Noise level	[dB (A)]	85			

Operating and environmental conditions				
ISO size	1, 2, 3	4		
Type of reset	Pneumatic	Mechanical	Pneumatic	
Operating medium	Filtered compressed air, lubricated or unlubricated Vacuum			
Operating pressure	[bar]	2 ... 16	-0.9 ... 16	-0.9 ... +16
Pilot pressure	[bar]	2 ... 16	3 ... 16	3 ... 16
Ambient temperature	[°C]	-10 ... +60		
Temperature of medium	[°C]	-10 ... +60		

Pneumatic valves VL, ISO 5599-1

Technical data – 5/2-way valves

Valve response times								
ISO size	1		2		3		4	
Type of reset	Pneumatic	Mechanical	Pneumatic	Mechanical	Pneumatic	Mechanical	Pneumatic	Mechanical
On	9	6	23	11	29	13	25	–
Off	18	23	39	39	36	43	90	–

Materials

Sectional view (ISO size 1, 2, 3)

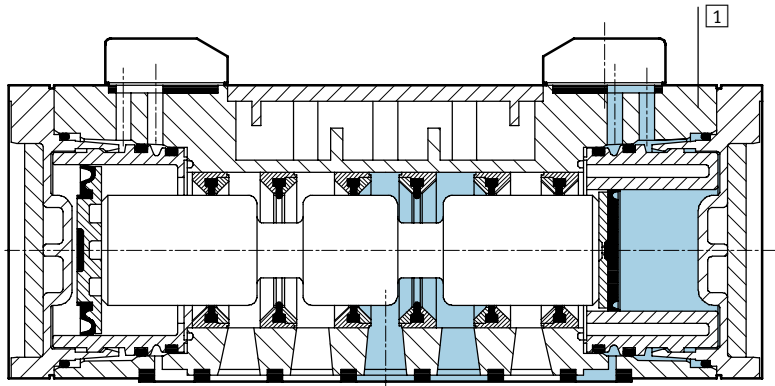

ISO size	1, 2, 3	4
1 Housing	Die-cast aluminium, polyacetate	Anodised aluminium, brass, polyurethane
– Seals	Nitrile rubber	Nitrile rubber, polytetrafluoroethylene carbon

Pneumatic valves VL, ISO 5599-1

Technical data – 5/2-way valves



Standard directional control valves
ISO 5599/1
1.2

Dimensions

Download CAD data → www.festo.com/en/engineering

ISO size 1, 2, 3

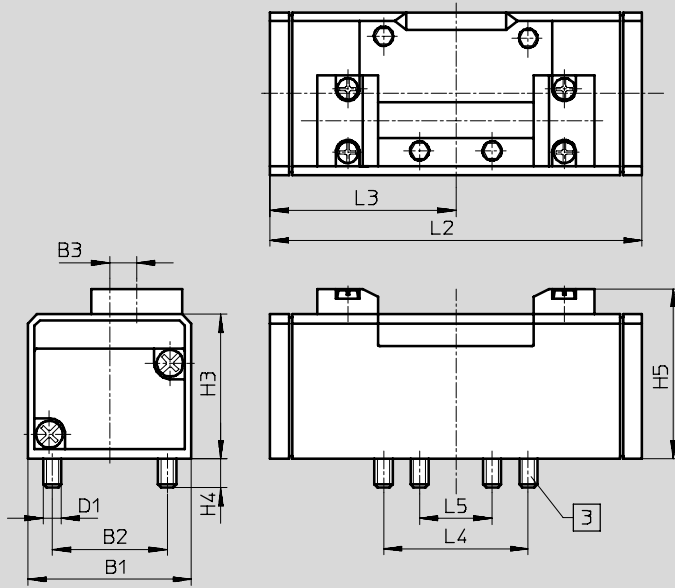

3 Captive mounting screws

Type	B1	B2	B3	D1	H3	H4	H5	L2	L3	L4	L5
ISO size 1											
VL-5/2-...	42	28	6	M5	38	9	46.5	87.6	43.8	36	18
VL-5/2-...-FR								98			
ISO size 2											
VL-5/2-...	54	38	9	M6	48	9.5	56.5	123.4	61.7	48	24
VL-5/2-...-FR								140.7			
ISO size 3											
VL-5/2-...	65	48	12	M8	55	12	63.5	145.4	72.7	64	32
VL-5/2-...-FR								164.7			

Pneumatic valves VL, ISO 5599-1

FESTO

Technical data – 5/2-way valves

Dimensions

Download CAD data → www.festo.com/en/engineering

ISO size 4

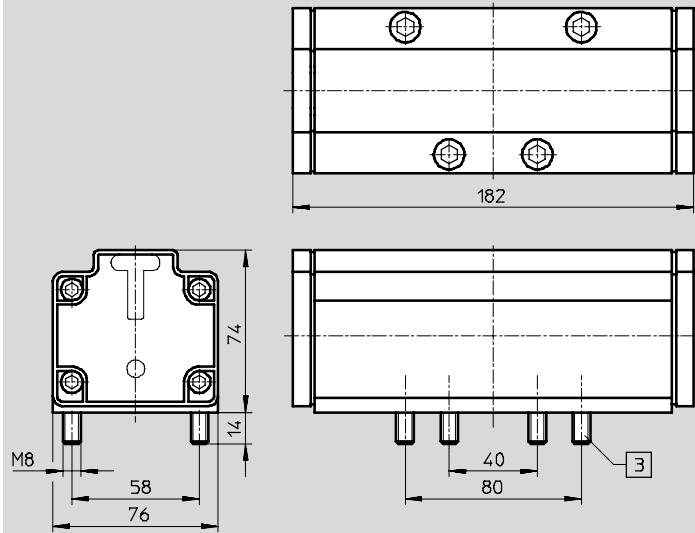

3 Captive mounting screws

Standard directional control valves
ISO 5599/1

1.2

Ordering data

Circuit symbol	Description	ISO size	Part No.	Type
	Pneumatic reset	1	151 009	VL-5/2-D-1-C
		2	151 845	VL-5/2-D-2-C
		3	151 864	VL-5/2-D-3-C
		4	12 461	VL-5/2-¾-D-4
	Mechanical reset	1	151 014	VL-5/2-D-1-FR-C
		2	151 844	VL-5/2-D-2-FR-C
		3	151 863	VL-5/2-D-3-FR-C

Pneumatic valves J, ISO 5599-1

Technical data – 5/2-way valves, double pilot

FESTO

-  - Flow rate
1200 ... 6000 l/min

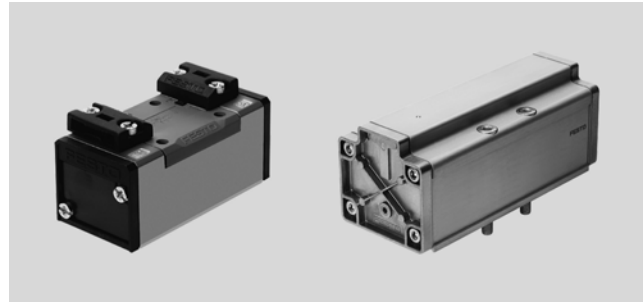

Standard directional control valves
ISO 5599/1

1.2

General technical data					
ISO size	1	2	3	4	
Valve function	5/2-way, double pilot				
Constructional design	Piston spool				
Sealing principle	Soft				
Actuation type	Pneumatic				
Type of pilot control	Direct				
Direction of flow	Reversible				
Exhaust function	With flow control				
Manual override	None				
Type of mounting	Via through-holes				
Mounting position	Any				
Nominal size	[mm]	8	11	14.5	18
Standard nominal flow rate	[l/min]	1200	2300	4500	6000
Grid dimension	[mm]	43	56	71	82
Pneumatic connection on sub-base	1, 2, 3, 4, 5	G $\frac{1}{4}$	G $\frac{3}{8}$	G $\frac{1}{2}$	G $\frac{3}{4}$
	12, 14	G $\frac{1}{8}$	G $\frac{1}{8}$	G $\frac{1}{8}$	G $\frac{1}{8}$
Product weight	[g]	290	550	810	1800
Noise level	[dB (A)]	85			

Operating and environmental conditions	
Operating medium	Filtered compressed air, lubricated or unlubricated Vacuum
Operating pressure	[bar] -0.9 ... 16
Pilot pressure	[bar] 2 ... 16
Ambient temperature	[°C] -10 ... +60
Temperature of medium	[°C] -10 ... +60

Valve response times [ms]					
ISO size	1		2, 3		4
	Dominant signal at 14		Dominant signal at 14		
	6	6/4	8	8	20

Pneumatic valves J, ISO 5599-1

Technical data – 5/2-way valves, double pilot

Materials

Sectional view (ISO size 4)

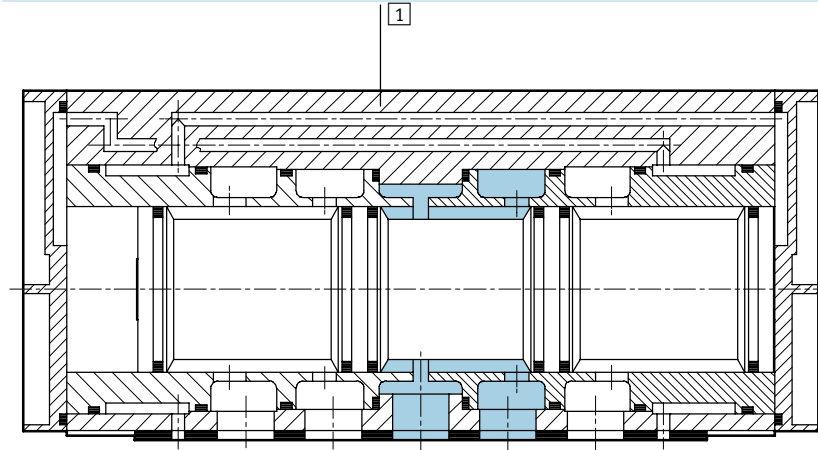

ISO size	1, 2, 3	4
1 Housing	Die-cast aluminium, polyacetate	Anodised aluminium, brass, polyurethane
- Seals	Nitrile rubber	Nitrile rubber, polytetrafluoroethylene carbon

Standard directional control valves
ISO 5599/1

1.2

Dimensions

Download CAD data → www.festo.com/en/engineering

ISO size 1, 2, 3

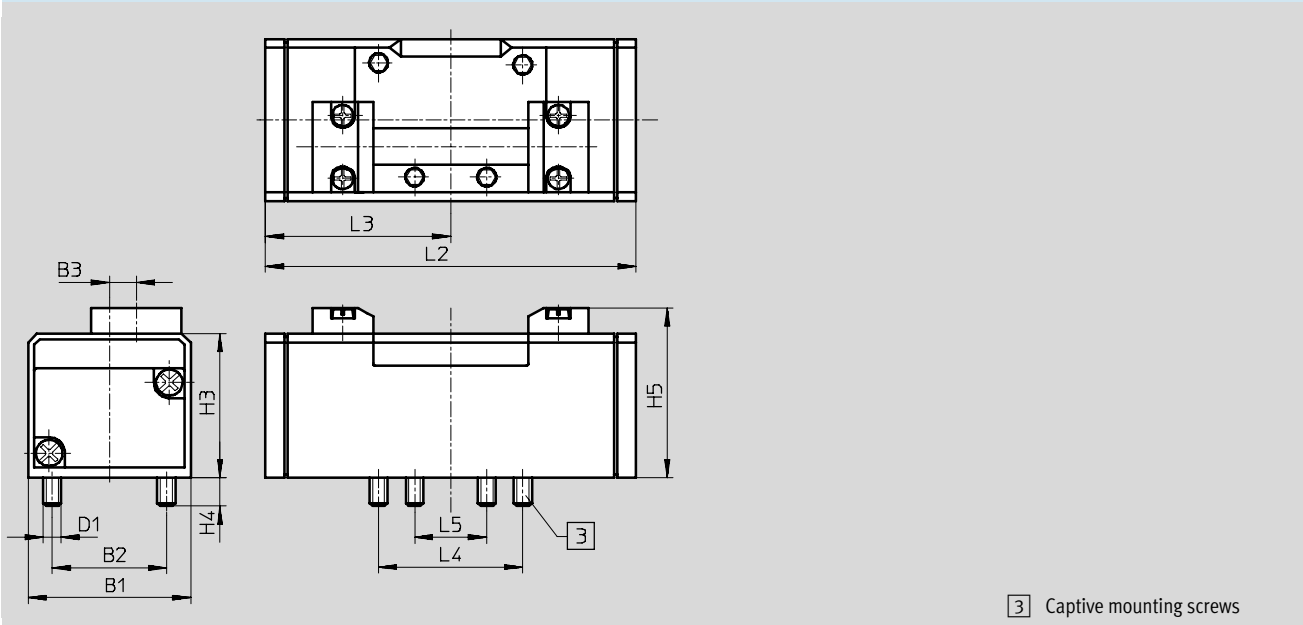

ISO size	B1	B2	B3	D1	H3	H4	H5	L2	L3	L4	L5
1	42	28	6	M5	38	9	46.5	87.6	43.8	36	18
2	54	38	9	M6	48	9.5	56.5	123.4	61.7	48	24
3	65	48	12	M8	55	12	63.5	145.4	72.7	64	32

Pneumatic valves J, ISO 5599-1

Technical data – 5/2-way valves, double pilot



Standard directional control valves
ISO 5599/1

1.2

Dimensions

Download CAD data → www.festo.com/en/engineering

ISO size 4

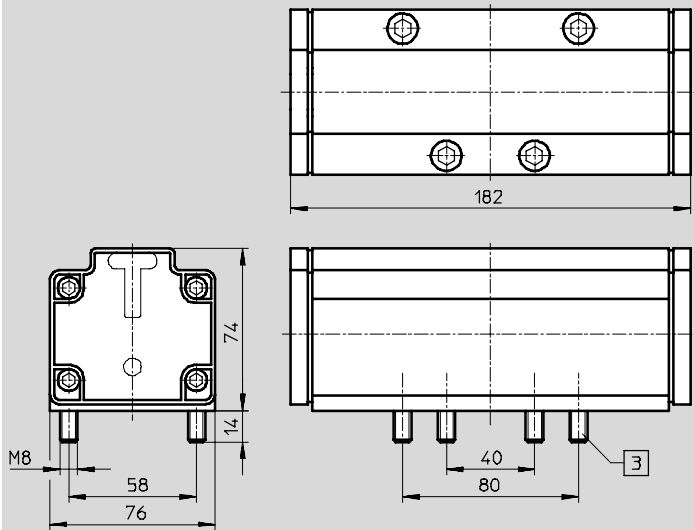

3 Captive mounting screws

Ordering data

Circuit symbol	Description	ISO size	Part No.	Type
		1	151 007	J-5/2-D-1-C
		2	151 846	J-5/2-D-2-C
		3	151 865	J-5/2-D-3-C
		4	12 462	J-5/2-¾-D-4
	With dominant signal at 14	1	151 008	JD-5/2-D-1-C
		2	151 847	JD-5/2-D-2-C
		3	151 866	JD-5/2-D-3-C

Pneumatic valves VL, ISO 5599-1

FESTO

Technical data – 5/3-way valves

-  - Flow rate
1200 ... 6000 l/min

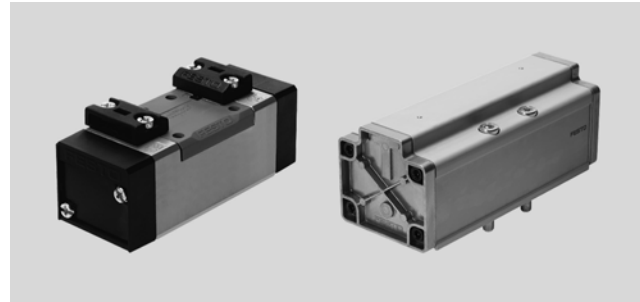

General technical data			1	2	3	4
ISO size			1	2	3	4
Valve function			5/3-way, single pilot			
Constructional design			Piston spool			
Sealing principle			Soft			
Actuation type			Pneumatic			
Type of reset			Mechanical spring			
Type of pilot control			Direct			
Pilot air supply			Internal			
Direction of flow			Reversible			
Exhaust function			With flow control			
Manual override			None			
Type of mounting			Via through-holes			
Mounting position			Any			
Nominal size	[mm]		8	11	14.5	18
Standard nominal flow rate	Closed	[l/min]	1200	2300	4100	6000
	Exhausted	[l/min]			4600	4800
	Pressurised	[l/min]			4100	–
Grid dimension	[mm]		43	56	71	82
Pneumatic connection on sub-base	1, 2, 3, 4, 5		G $\frac{1}{4}$	G $\frac{3}{8}$	G $\frac{1}{2}$	G $\frac{3}{4}$
	12, 14		G $\frac{1}{8}$	G $\frac{1}{8}$	G $\frac{1}{8}$	G $\frac{1}{8}$
Product weight	[g]		320	825	910	2000
Noise level	[dB (A)]		85			

Operating and environmental conditions	
Operating medium	Filtered compressed air, lubricated or unlubricated Vacuum
Operating pressure	[bar] –0.9 ... +16
Pilot pressure	[bar] 3 ... 16
Ambient temperature	[°C] –10 ... +60
Temperature of medium	[°C] –10 ... +60

Valve response times								
ISO size	1		2		3		4	
	On	Off	On	Off	On	Off	On	Off
Closed	7	45	15	56	17	61	40	130
Exhausted	7	45	16	59	18	63	40	130
Pressurised	7	45	15	57	16	60	–	–

Standard directional control valves
ISO 5599/1
1.2

Pneumatic valves VL, ISO 5599-1

Technical data – 5/3-way valves



Standard directional control valves
ISO 5599/1
1.2

Materials

Sectional view (ISO size 4)

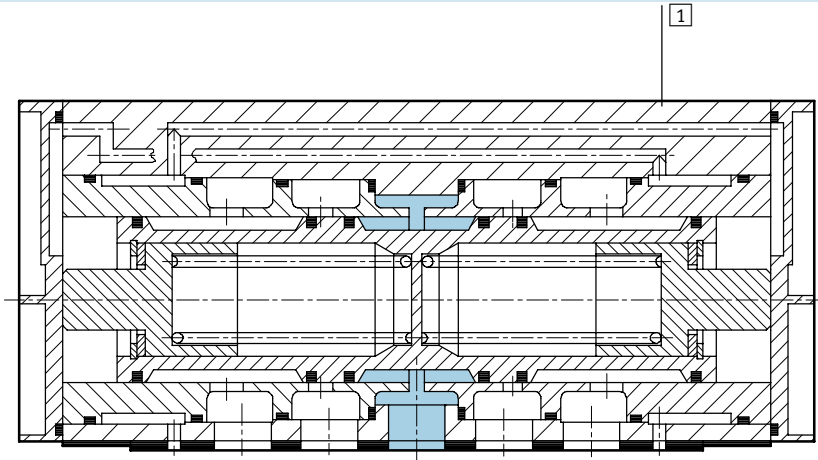

ISO size	1, 2, 3	4
1 Housing	Die-cast aluminium, polyacetate	Anodised aluminium, brass, polyurethane
- Seals	Nitrile rubber	Nitrile rubber, polytetrafluoroethylene carbon

Dimensions

Download CAD data → www.festo.com/en/engineering

ISO size 1, 2 and 3

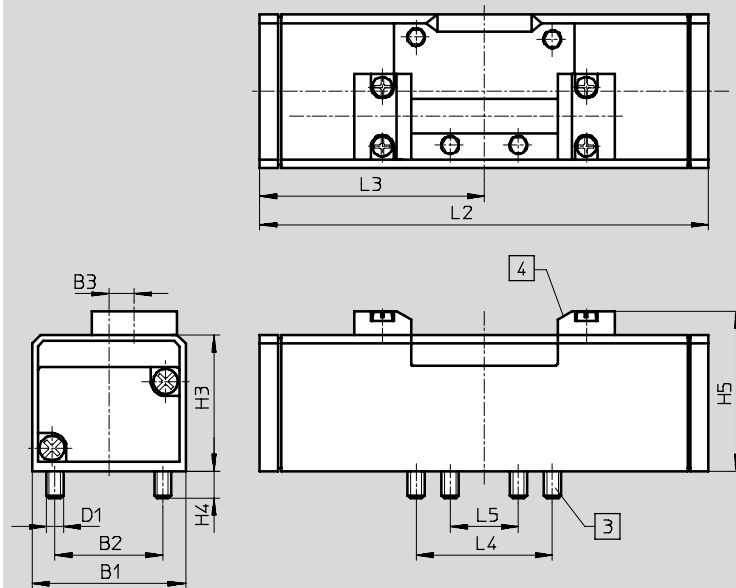

- 3 Captive mounting screws
- 4 Slot for inscription label

ISO size	B1	B2	B3	D1	H3	H4	H5	L2	L3	L4	L5
1	42	28	6	M5	38	9	46.5	108.4	54.2	36	18
2	54	38	9	M6	48	9.5	56.5	158	79	48	24
3	65	48	12	M8	55	12	63.5	184	92	64	32

Pneumatic valves VL, ISO 5599-1

FESTO

Technical data – 5/3-way valves

Dimensions

Download CAD data → www.festo.com/en/engineering

ISO size 4

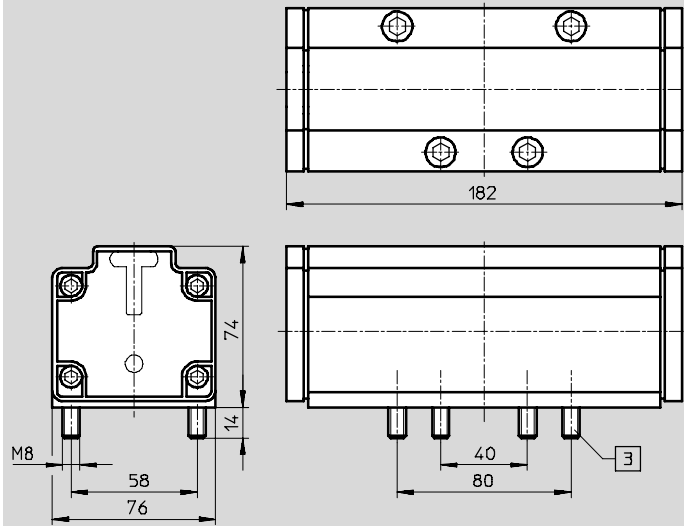

3 Captive mounting screws

Standard directional control valves
ISO 5599/1

1.2

Ordering data

Circuit symbol	Description	ISO size	Part No.	Type
	Normally closed, mechanical reset	1	151 010	VL-5/3G-D-1-C
		2	151 848	VL-5/3G-D-2-C
		3	151 867	VL-5/3G-D-3-C
		4	12 463	VL-5/3G-¾-D-4
	Normally exhausted, mechanical reset	1	151 011	VL-5/3E-D-1-C
		2	151 849	VL-5/3E-D-2-C
		3	151 868	VL-5/3E-D-3-C
		4	12 464	VL-5/3E-¾-D-4
	Normally pressurised, mechanical reset	1	151 012	VL-5/3B-D-1-C
		2	151 850	VL-5/3B-D-2-C
		3	151 869	VL-5/3B-D-3-C

Solenoid/pneumatic valves, ISO 5599-1

Accessories

FESTO

Individual sub-base

NAS

Lateral ports

Material:

Size 1, 2, 3

Die-cast aluminium

Size 4

Anodised aluminium

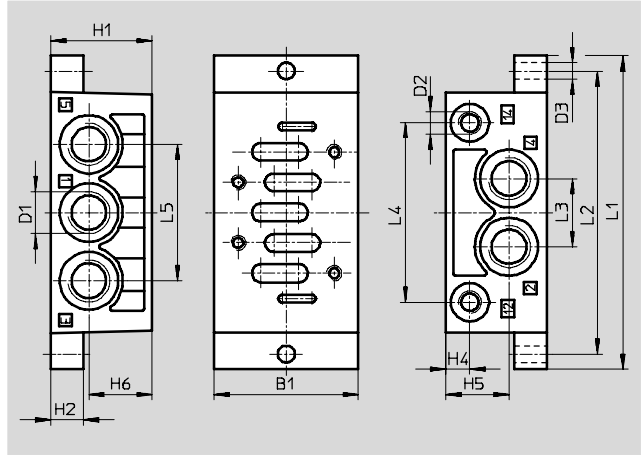

Dimensions and ordering data																	
ISO size	B1	D1	D2	D3 ∅	H1	H2	H4	H5	H6	L1	L2	L3	L4	L5	Weight [g]	Part No.	Type
1	48	G $\frac{1}{4}$	G $\frac{1}{8}$	5.5	32	10	9	20.3	20.3	110	98	23	60	46	190	9 484	NAS- $\frac{1}{4}$ -1A-ISO ¹⁾
2	57	G $\frac{3}{8}$	G $\frac{1}{8}$	6.6	40	13	9	25	25	124	112	27	71	54	300	11 310	NAS- $\frac{3}{8}$ -2A-ISO ¹⁾
3	71	G $\frac{1}{2}$	G $\frac{1}{8}$	6.6	32	18	9	16	16	149	136	32	91	64	360	10 336	NAS- $\frac{1}{2}$ -3A-ISO ¹⁾
4	85	G $\frac{3}{4}$	G $\frac{1}{8}$	9	42	19	9	21	21	186	170	42	111	84	1260	152 813	NAS- $\frac{3}{4}$ -4A-ISO

1) Free of copper, PTFE and silicone

General technical data				
ISO size	1	2	3	4
Type of mounting	2 through-holes in housing			
Pneumatic connection	1, 2, 3, 4, 5	G $\frac{1}{4}$	G $\frac{3}{8}$	G $\frac{1}{2}$
	12, 14	G $\frac{1}{8}$	G $\frac{1}{8}$	G $\frac{1}{8}$

Solenoid/pneumatic valves, ISO 5599-1

FESTO

Accessories

Individual sub-base

NAU

Ports underneath

Material:

Size 1, 2, 3

Die-cast aluminium

Size 4

Anodised aluminium

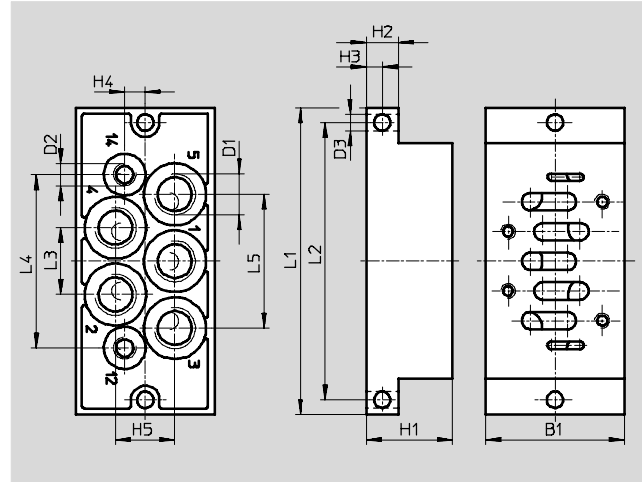

Dimensions and ordering data																	
ISO size	B1	D1	D2	D3 Ø	H1	H2	H3	H4	H5	L1	L2	L3	L4	L5	Weight [g]	Part No.	Type
1	46	G $\frac{1}{4}$	G $\frac{1}{8}$	5.5	30	10	5	7.5	20	110	98	23	60.7	46	280	9 485	NAU- $\frac{1}{4}$ -1B-ISO ¹⁾
2	56	G $\frac{3}{8}$	G $\frac{1}{8}$	6.6	35	13	6.5	8.3	24	124	112	27	70	54	450	11 416	NAU- $\frac{3}{8}$ -2B-ISO ¹⁾
3	71	G $\frac{1}{2}$	G $\frac{1}{8}$	6.6	32	18	9	10	30	149	136	32	90	66	660	10 337	NAU $\frac{1}{2}$ -3B-ISO ¹⁾
4	85	G $\frac{3}{4}$	G $\frac{1}{8}$	9	28	19	9.5	12	37	186	170	42	111	84	1080	152 814	NAU- $\frac{3}{4}$ -4B-ISO

1) Free of copper, PTFE and silicone

General technical data				
ISO size	1	2	3	4
Type of mounting	2 through-holes in housing			
Pneumatic connection	1, 2, 3, 4, 5	G $\frac{1}{4}$	G $\frac{3}{8}$	G $\frac{1}{2}$
	12, 14	G $\frac{1}{8}$	G $\frac{1}{8}$	G $\frac{1}{8}$

Standard directional control valves
ISO 5599/1

1.2

Solenoid/pneumatic valves, ISO 5599-1

FESTO

Accessories

Manifold sub-base NAV

Ports underneath

Material:

Size 1, 2, 3

Die-cast aluminium

Size 4

Anodised aluminium



Ordering data					
ISO size	Pneumatic connection		Weight [g]	Part No.	Type
	1, 2, 3, 4, 5	12, 14			
1	G1/4	G1/8	240	10 173	NAV-1/4-1C-ISO
2	G3/8	G1/8	400	11 305	NAV-3/8-2C-ISO
3	G1/2	G1/8	700	10 175	NAV-1/2-3C-ISO
4	G3/4	G1/8	1400	11 139	NAV-3/4-4C-ISO

Dimensions → 2 / 1.2-93

Standard directional control valves
ISO 5599/1

1.2

Angle connection block NAW

Ports at side and underneath

Material:

Size 1, 2, 3

Die-cast aluminium

Size 4

Anodised aluminium

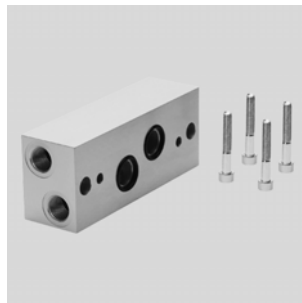

Ordering data					
ISO size	Pneumatic connection		Weight [g]	Part No.	Type
	1, 2, 3, 4, 5	12, 14			
1	G1/4	G1/8	360	11 304	NAW-1/4-1E-ISO ¹⁾
2	G3/8	G1/8	600	11 307	NAW-3/8-2E-ISO ¹⁾
3	G1/2	G1/8	920	11 309	NAW-1/2-3E-ISO ¹⁾
4	G3/4	G1/8	1550	11 141	NAW-3/4-4E-ISO

Dimensions → 2 / 1.2-93

1) Free of copper, PTFE and silicone

Solenoid/pneumatic valves, ISO 5599-1

Accessories

Manifold sub-base for angle connection NAVW

Ports at side and underneath

Material:

Size 1, 2, 3

Die-cast aluminium

Size 4

Anodised aluminium



Ordering data					
ISO size	Pneumatic connection		Weight [g]	Part No.	Type
	1, 2, 3, 4, 5	12, 14			
1	G $\frac{1}{4}$	G $\frac{1}{8}$	320	152 789	NAVW- $\frac{1}{4}$ -1-ISO
2	G $\frac{3}{8}$	G $\frac{1}{8}$	550	152 790	NAVW- $\frac{3}{8}$ -2-ISO
3	G $\frac{1}{2}$	G $\frac{1}{8}$	1020	152 791	NAVW- $\frac{1}{2}$ -3-ISO

Dimensions → 2 / 1.2-93

End plate kit NEV

Material:

Size 1, 2, 3

Die-cast aluminium

Size 4

Anodised aluminium

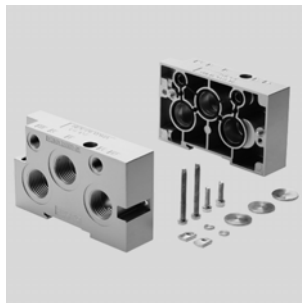

Ordering data					
ISO size	Pneumatic connection		Weight [g]	Part No.	Type
	1, 2, 3, 4, 5	12, 14			
1	G $\frac{3}{8}$	–	280	10 174	NEV-1DA/DB-ISO ¹⁾
2	G $\frac{1}{2}$	–	450	11 306	NEV-2DA/DB-ISO ¹⁾
3	G1	–	760	10 176	NEV-3DA/DB-ISO ¹⁾
4	G1	–	1390	11 140	NEV-4DA/DB-ISO

Dimensions → 2 / 1.2-93

1) Free of copper, PTFE and silicone

Solenoid/pneumatic valves, ISO 5599-1

Accessories

FESTO

Blanking plate NDV

Material:
Size 1, 2, 3
Steel

Size 4
Wrought aluminium alloy



Ordering data			
ISO size	Weight [g]	Part No.	Type
1	113	9 489	NDV-1-ISO
2	166	11 308	NDV-2-ISO
3	314	10 340	NDV-3-ISO
4	1480	11 142	NDV-4-ISO

Dimensions → 2 / 1.2-93

Standard directional control valves
ISO 5599/1

1.2

Isolating disc NSC

Material:
Wrought aluminium alloy



Ordering data					
ISO size	Pneumatic connection		Weight [g]	Part No.	Type
	1, 2, 3	12, 14			
1	1/4	–	6	11 550	NSC-1/4-1-ISO ¹⁾
2	3/8	–	9.2	11 908	NSC-3/8-2-ISO ¹⁾
3	1/2	–	20	11 551	NSC-1/2-3-ISO ¹⁾
4	3/4	–	24	11 699	NSC-3/4-4-ISO

Dimensions → 2 / 1.2-93

1) Free of copper, PTFE and silicone

Solenoid/pneumatic valves, ISO 5599-1

Accessories

FESTO

Dimensions – Manifold mounting

Download CAD data → www.festo.com/en/engineering

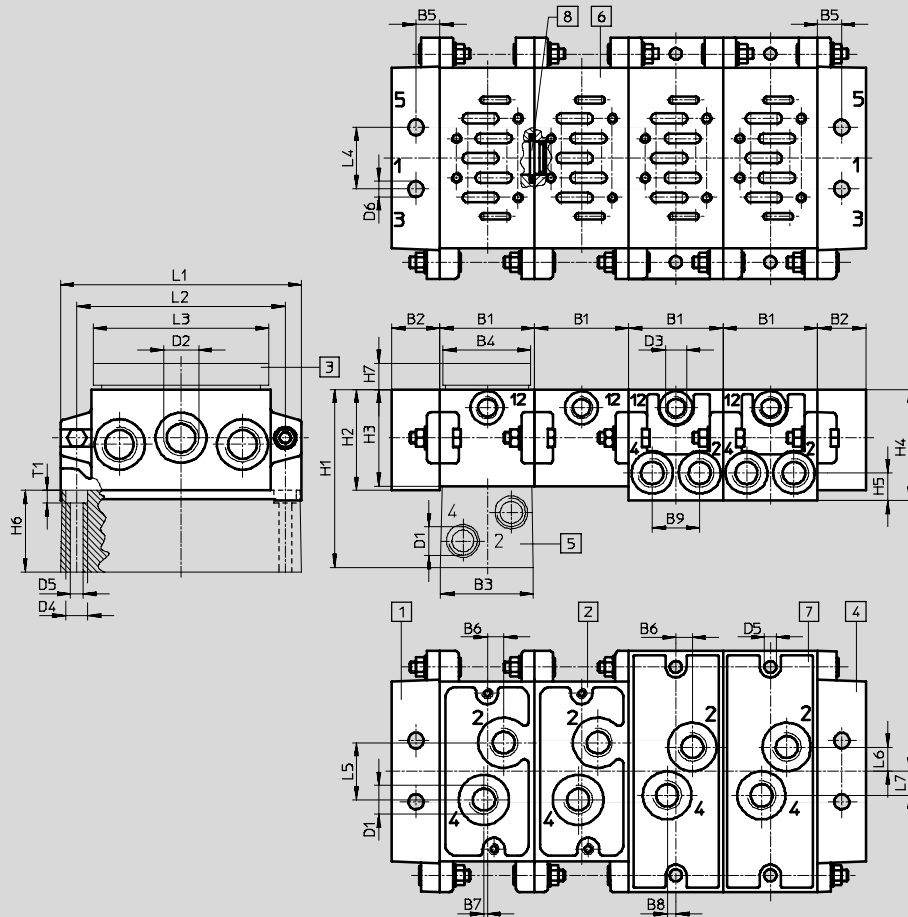

- 1 Left-hand end plate
- 2 Manifold sub-base NAV
- 3 Blanking plate NDV
- 4 Right-hand end plate
- 5 Angle connection block NAW
- 6 Port pattern to ISO 5599-1
- 7 Manifold sub-base for angle connection NAWW
- 8 Isolating disc NSC

ISO size	B1	B2	B3	B4	B5	B6	B7	B8	B9	D1	D2	D3	D4 Ø	D5 Ø	D6 Ø
1	43	22	42	40	11	7.5	1.5	4	21.6	G $\frac{1}{4}$	G $\frac{3}{8}$	G $\frac{1}{8}$	10	5.5	7
2	56	26	55	50	13	6	5	6	27	G $\frac{3}{8}$	G $\frac{1}{2}$	G $\frac{1}{8}$	11	6.6	9
3	71	30	70	70	15	8	6	6	35.5	G $\frac{1}{2}$	G1	G $\frac{1}{8}$	15	9	12
4	82	30	80	80	15	9	8	-	-	G $\frac{3}{4}$	G1	G $\frac{1}{8}$	15	9	12

ISO size	H1	H2	H3	H4	H5	H6	H7	L1	L2	L3	L4	L5	L6	L7	T1
1	81	46	44	50.5	12.5	37	5	110	95	80	28	26	11	11	5.7
2	85	47	45	60	15	40	5	135	115	96	35	30	15	14	6.8
3	99	56	54	66	17.5	45	5	190	168	120	52	38	19	19	9
4	120	58	55	-	-	65	5	215	184	-	56	52	-	-	9

Standard directional control valves
ISO 5599/1

1.2

Solenoid/pneumatic valves, ISO 5599-1

Accessories



Intermediate plate NZV

for connecting manifold sub-bases of different sizes

Material:

Die-cast aluminium, anodised
Free of copper, PTFE and silicone

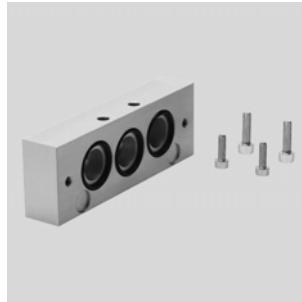

Standard directional control valves
ISO 5599/1
1.2

Dimensions

Download CAD data → www.festo.com/en/engineering

Intermediate plates NZV – ISO size 1, 2, 3

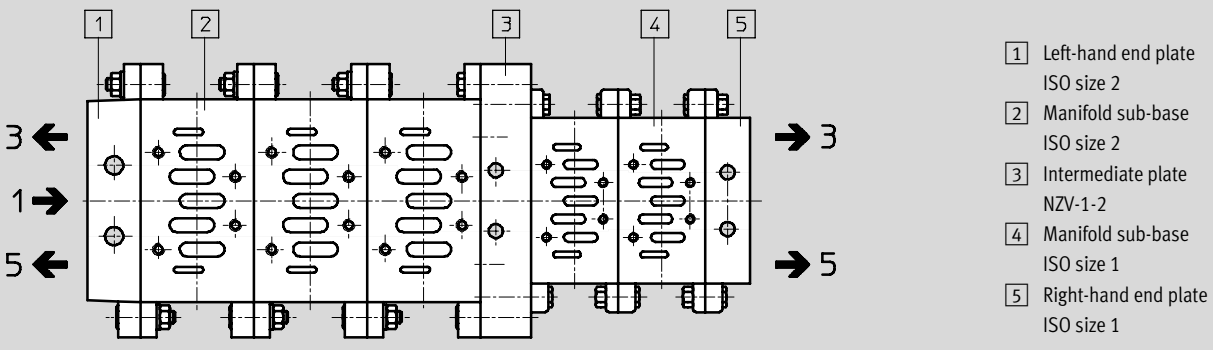

NZV-1-2

NZV-3-2/1

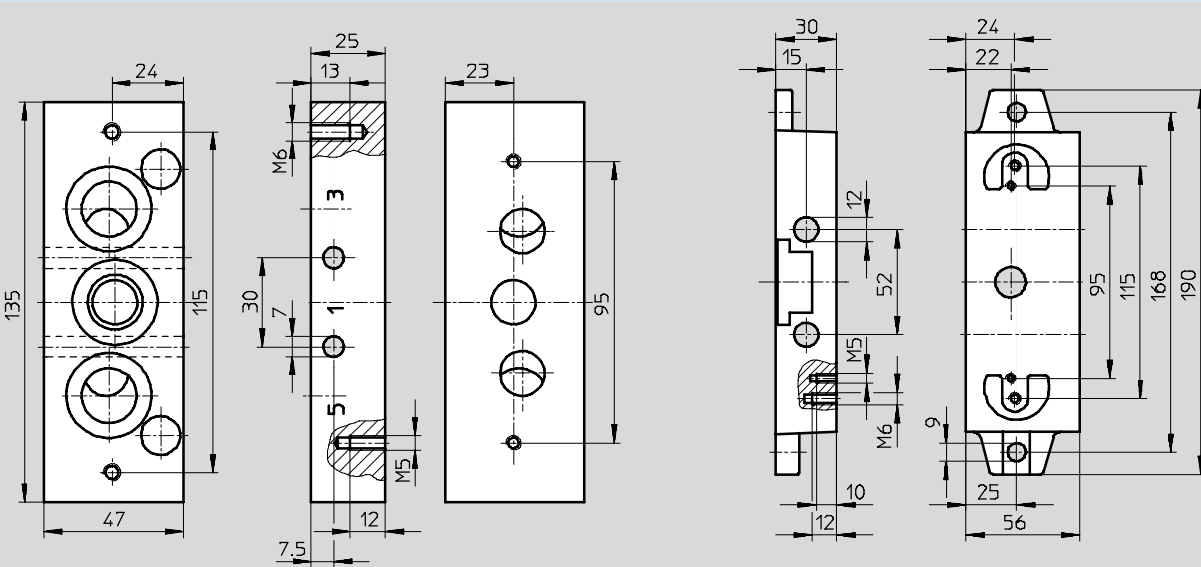

Ordering data

Weight [g]	Part No.	Type
For manifold sub-bases ISO size 1 and 2		
393	164 940	NZV-1-2
For manifold sub-bases ISO size 1 and 3 or size 2 and 3		
473	12 911	NZV-3-2/1

Solenoid/pneumatic valves, ISO 5599-1



Accessories

Throttle plates GRO

Exhaust air restrictor for 3 and 5

Material:
Anodised aluminium, brass

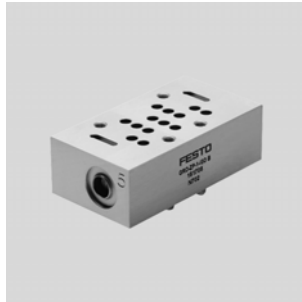

Standard nominal flow rate q_{nN} as a function of the turns n of the adjusting screw

GRO-ZP-1-ISO-B

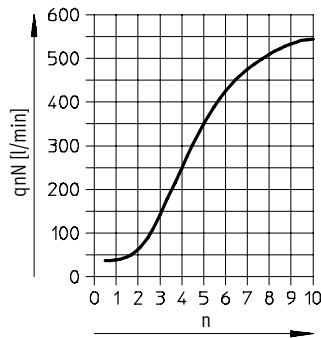

GRO-ZP-2-ISO-B

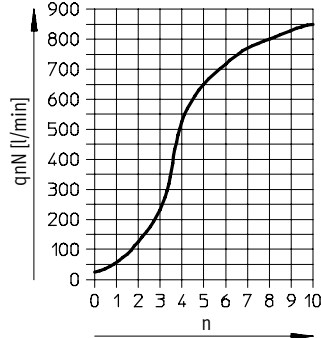

GRO-ZP-3-ISO-B

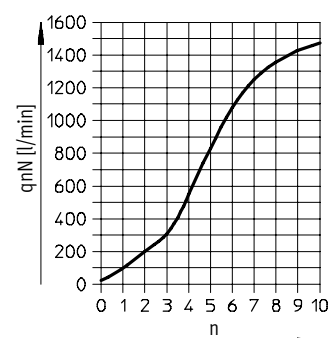

Standard directional control valves
ISO 5599/1
1.2

Dimensions

Download CAD data → www.festo.com/en/engineering

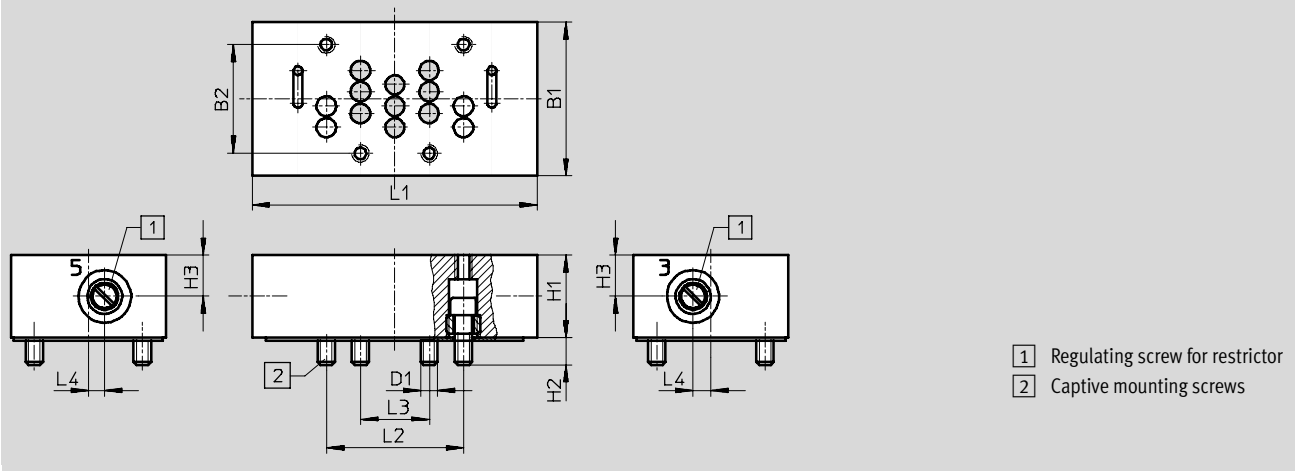

Dimensions and ordering data

ISO size	D1	B1	B2	H1	H2	H3	L1	L2	L3	L4	Weight [g]	Part No.	Type
1	M5	42	28	25	6.5	12.5	77	36	18	6	230	151 705	GRO-ZP-1-ISO-B
2	M6	54	38	29	9.5	14.5	100	48	24	6.3	440	151 706	GRO-ZP-2-ISO-B
3	M8	70	48	33	12	16.5	132	64	32	7	850	151 707	GRO-ZP-3-ISO-B

Solenoid/pneumatic valves, ISO 5599-1

Accessories



Intermediate pressure regulator plate LR-ZP

Material:
Housing:
Die-cast aluminium, steel
Seals:
Nitrile rubber



Flow rate q_n as a function of the output pressure p_2

LR-ZP-A-D-1, LR-ZP-B-1,
LR-ZP-A/B-1

LR-ZP-P-D-1

LR-ZP-A-D-2, LR-ZP-B-2,
LR-ZP-A/B-2

LR-ZP-P-D-2

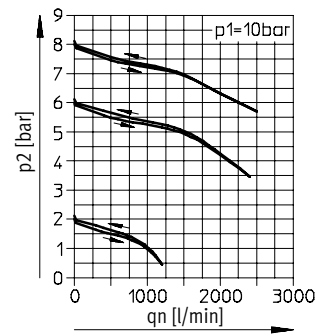
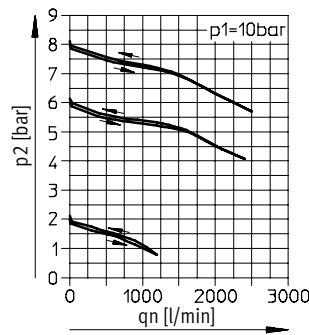
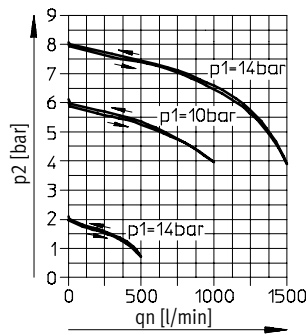
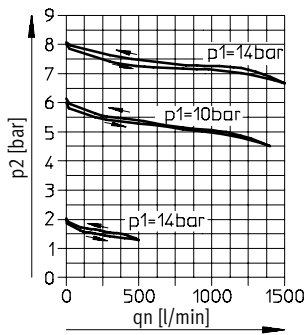

LR-ZP-A-D-3, LR-ZP-B-3,
LR-ZP-A/B-3

LR-ZP-P-D-3

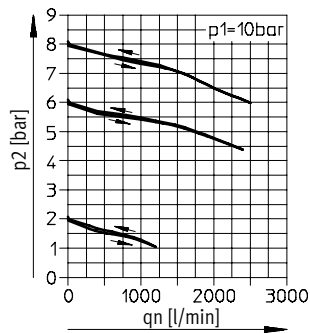
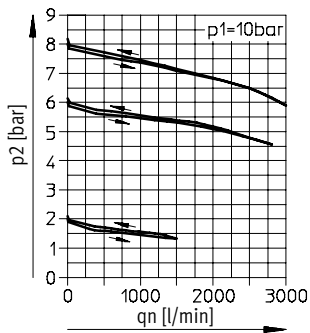

Pressure regulation

Port 1 regulated

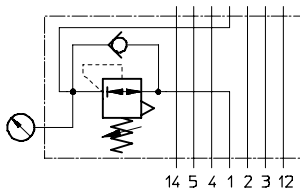

Port 2 regulated

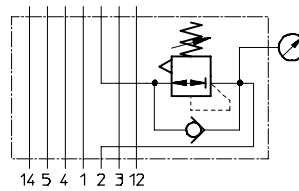

Port 4 regulated

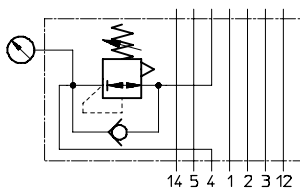

Ports 2 and 4 regulated

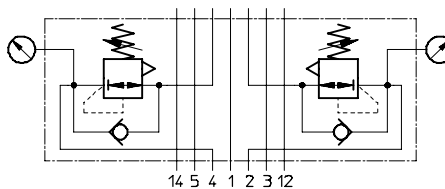

Solenoid/pneumatic valves, ISO 5599-1

Accessories

FESTO

Dimensions

Download CAD data → www.festo.com/en/engineering

Intermediate pressure regulator plates LR-ZP – ISO size 1, 2, 3

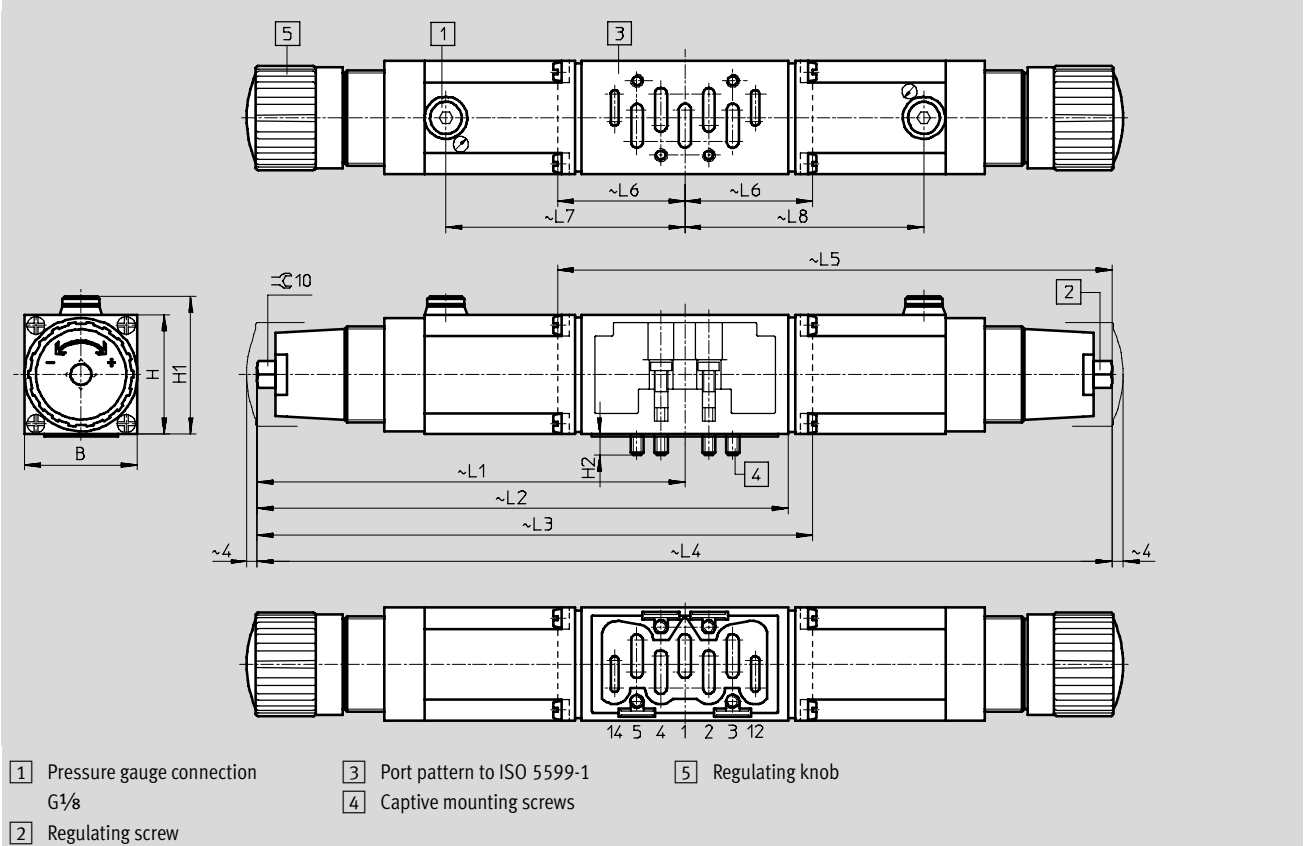

Standard directional control valves
ISO 5599/1

1.2

Solenoid/pneumatic valves, ISO 5599-1

Accessories

FESTO

Standard directional control valves
ISO 5599/1
1.2

Dimensions and ordering data																				
Regulated port	B	H	H1	H2	L1	L2	L3	L4	L5	L6	L7	L8	Weight [g]	Part No.	Type					
ISO size 1																				
1	42.6	45	52	8	161	-	209	-	-	48	90	-	520	35 966	LR-ZP-P-D-1					
																	165 859	LR-ZP-P-D-1-CT¹⁾		
2									-	-	-	209	48	-	90	520	35 424	LR-ZP-B-D-1		
																	165 856	LR-ZP-B-D-1-CT¹⁾		
4									161	-	-	322	-	-	90	90	520	35 969	LR-ZP-A-D-1	
																		165 850	LR-ZP-A-D-1-CT¹⁾	
2, 4									161	200	-	-	-	-	90	-	840	35 427	LR-ZP-A/B-D-1	
																		165 853	LR-ZP-A/B-D-1-CT¹⁾	
ISO size 2																				
1	54	58	62.5	10	188	-	247	-	-	-	105.5	-	960	35 967	LR-ZP-P-D-2					
																	165 860	LR-ZP-P-D-2-CT¹⁾		
2									-	-	-	247	59	-	105.5	960	35 425	LR-ZP-B-D-2		
																	165 857	LR-ZP-B-D-2-CT¹⁾		
4									188	-	-	376	-	-	105.5	105.5	960	35 970	LR-ZP-A-D-2	
																		165 851	LR-ZP-A-D-2-CT¹⁾	
2, 4									188	233	-	-	-	-	105.5	-	1490	35 428	LR-ZP-A/B-D-2	
																		165 854	LR-ZP-A/B-D-2-CT¹⁾	
ISO size 3																				
1	70	63	65	14	201.5	-	274	-	-	-	119	-	1220	35 968	LR-ZP-P-D-3					
																		165 861	LR-ZP-P-D-3-CT¹⁾	
2											-	-	-	274	72.5	-	119	1220	35 426	LR-ZP-B-D-3
																			165 858	LR-ZP-B-D-3-CT¹⁾
4											-	-	403	-	-	119	119	1220	35 971	LR-ZP-A-D-3
																			165 852	LR-ZP-A-D-3-CT¹⁾
2, 4											260	-	-	-	-	119	-	1770	35 429	LR-ZP-A/B-D-3
																			165 855	LR-ZP-A/B-D-3-CT¹⁾

1) Free of copper, PTFE and silicone

Ordering data – Pressure gauge for intermediate pressure regulator plates LR-ZP			
ISO size	Weight [g]	Part No.	Type
1, 2, 3	64.5	345 395	MA-40-16-1/8

Solenoid/pneumatic valves, ISO 5599-1



Accessories

Manual override tool AHB

Material:
Polymer

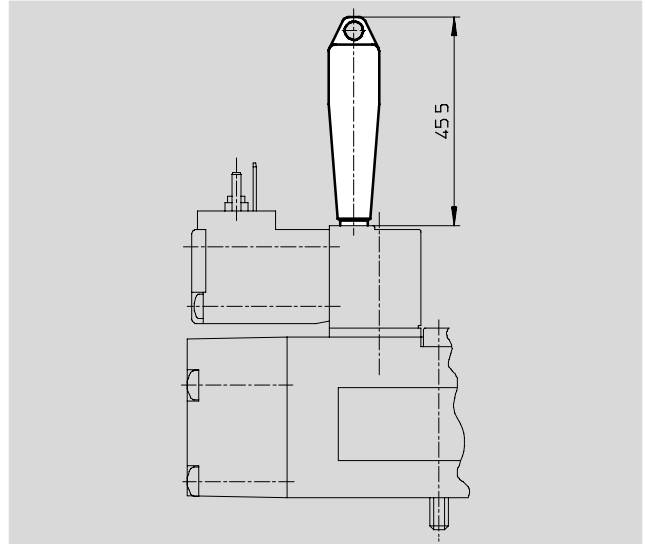

Ordering data			
For valve	Weight [g]	Part No.	Type
MEBH	5	157 601	AHB-MEB
MN1H/MFH	10	157 651	AHB-MD/MF/MV

Inscription labels IBS-9x17

Material:
Polymer

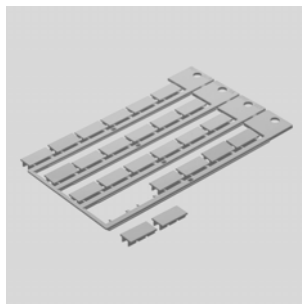

Ordering data		
	Part No.	Type
Inscription label for valves (24 in frames included in scope of delivery)	161 937	IBS-9x17

Standard directional control valves
ISO 5599/1

1.2

 Core Range



Solenoid/pneumatic valves, ISO 5599-1



Accessories

FESTO

Standard directional control valves
ISO 5599/1

1.2

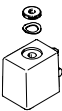
Ordering data		Part No.	Type
Push-in fittings QS			
		→	Volume 3 → www.festo.com
Silencers			
		→	Volume 3 → www.festo.com

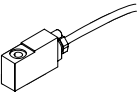

Ordering data – Solenoid coils		Technical data → NO TAG	
Ordering data – Solenoid coils		Technical data → www.festo.com	
	Voltage	Cable length [m]	Part No. Type
F solenoid coils for valves MFH, JMFH			
	12 V DC	–	34 410 MSFG-12DC-OD
	24 V DC and 42 V AC, 50 ... 60 Hz	–	34 411 MSFG-24DC/42AC-OD
	42 V DC	–	34 413 MSFG-42DC-OD
	24 V AC	–	34 415 MSFG-24AC-OD
	48 V AC, 50 ... 60 Hz	–	34 418 MSFW-48AC-OD
	110 V AC, 50 ... 60 Hz and 120 V AC, 60 Hz	–	34 420 MSFW-110AC-OD
	230 V AC, 50 ... 60 Hz and 240 V AC, 60 Hz	–	34 422 MSFW-230AC-OD
	240 V AC, 50 ... 60 Hz	–	34 424 MSFW-240AC-OD
N1 solenoid coils for valves MN1H, JMN1H			
	24 V DC	–	123 060 MSN1G-24DC-OD
	12 V DC and 24 V AC, 50 ... 60 Hz	–	170 152 MSN1W-24AC/12DC-OD
	110 V AC, 50 ... 60 Hz	–	123 061 MSN1W-110AC-OD
	230 V AC, 50 ... 60 Hz	–	123 062 MSN1W-230AC-OD
F solenoid coils for valves MFH, JMFH – Explosion-proof to EN 50 028			
	24 V DC	1	535 619 MSFG-24DC-EX
	24 V DC	5	535 621 MSFG-24DC-EX-K5
	24 V AC, 50 ... 60 Hz	1	535 623 MSFW-24AC-EX
	110 V AC, 50 ... 60 Hz	1	535 622 MSFW-110AC-EX
	230 V AC, 50 ... 60 Hz	1	535 620 MSFW-110AC-EX
	230 V AC, 50 ... 60 Hz	5	535 625 MSFW-110AC-EX-K5

 Core Range

Solenoid/pneumatic valves, ISO 5599-1

Accessories

FESTO

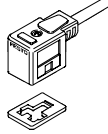
Ordering data – Plug sockets, plug sockets with cable for F solenoid coils					
	Voltage	Cable length [m]	Switching status display with LED	Part No.	Type
Plug socket without cable				Technical data → NO TAG	
Plug socket without cable				Technical data → www.festo.com	
	–	–	–	34 431	MSSD-F
	–	–	–	59 710	MSSD-F-M16
Plug socket without cable with insulation displacement technology				Technical data → NO TAG	
Plug socket without cable with insulation displacement technology				Technical data → www.festo.com	
	–	–	–	192 746	MSSD-F-S-M16
Plug socket with cable				Technical data → NO TAG	
Plug socket with cable				Technical data → www.festo.com	
	24 V DC	2.5	■	30 935	KMF-1-24DC-2,5-LED
	24 V DC	5	■	30 937	KMF-1-24DC-5-LED
	24 V DC	10	■	193 458	KMF-1-24DC-10-LED
	Up to 240 V	2.5	–	30 936	KMF-1-230AC-2,5
	Up to 240 V	5	–	30 938	KMF-1-230AC-5

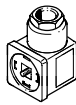
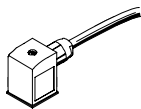
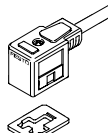
Ordering data – Plug sockets, plug sockets with cable for N1 and D solenoid coils					
	Voltage	Cable length [m]	Switching status display with LED	Part No.	Type
Plug socket without cable				Technical data → NO TAG	
Plug socket without cable				Technical data → www.festo.com	
	–	–	–	34 583	MSSD-C
	–	–	–	539 709	MSSD-C-M16
Plug socket without cable with insulation displacement technology				Technical data → NO TAG	
Plug socket without cable with insulation displacement technology				Technical data → www.festo.com	
	–	–	–	192 748	MSSD-C-S-M16
Plug socket with cable				Technical data → NO TAG	
Plug socket with cable				Technical data → www.festo.com	
	24 V DC	2.5	■	30 931	KMC-1-24DC-2,5-LED
	24 V DC	5	■	30 933	KMC-1-24DC-5-LED
	24 V DC	10	■	193 459	KMC-1-24DC-10-LED
	Up to 230 V	2.5	–	30 932	KMC-1-230AC-2,5
	Up to 230 V	5	–	30 934	KMC-1-230AC-5

 Core Range



Solenoid/pneumatic valves, ISO 5599-1



Accessories

FESTO

Standard directional control valves
ISO 5599/1

1.2

Ordering data – Plug sockets, plug sockets with cable for valves with central plug				
	Voltage	Cable length [m]	Switching status display with LED	Part No. Type
Plug socket without cable				Technical data → NO TAG
Plug socket without cable				Technical data → www.festo.com
	–	–	–	185 498 SEA-M12-4WD-PG7
Plug socket with cable				Technical data → NO TAG
Plug socket with cable				Technical data → www.festo.com
	–	–	–	185 499 KM-12-M12-GSWD-1-4

Ordering data – Illuminating seal				Technical data → NO TAG
Ordering data – Illuminating seal				Technical data → www.festo.com
	Voltage	Part No.	Type	
For F solenoid coils				
	12 ... 24 V DC	19 143	MF-LD-12-24DC	
	230 V DC/V AC	19 144	MF-LD-230AC	
For N1 solenoid coils				
	12 ... 24 V DC	19 145	MC-LD-12-24DC	
	230 V DC/V AC	19 146	MC-LD-230AC	

 Core Range