

- Electrically or pneumatically actuated valves
- With internal or external pilot air
- Pneumatic or mechanical reset
- Pressure regulator plate, flow control plate, vertical isolating plate and vertical supply plate as a vertical stacking construction
- Combi manifold with widths of 18 mm and 26 mm
- Electrical connection via round or square plug socket

Solenoid valves VSVA, ISO 15407-1

Key features

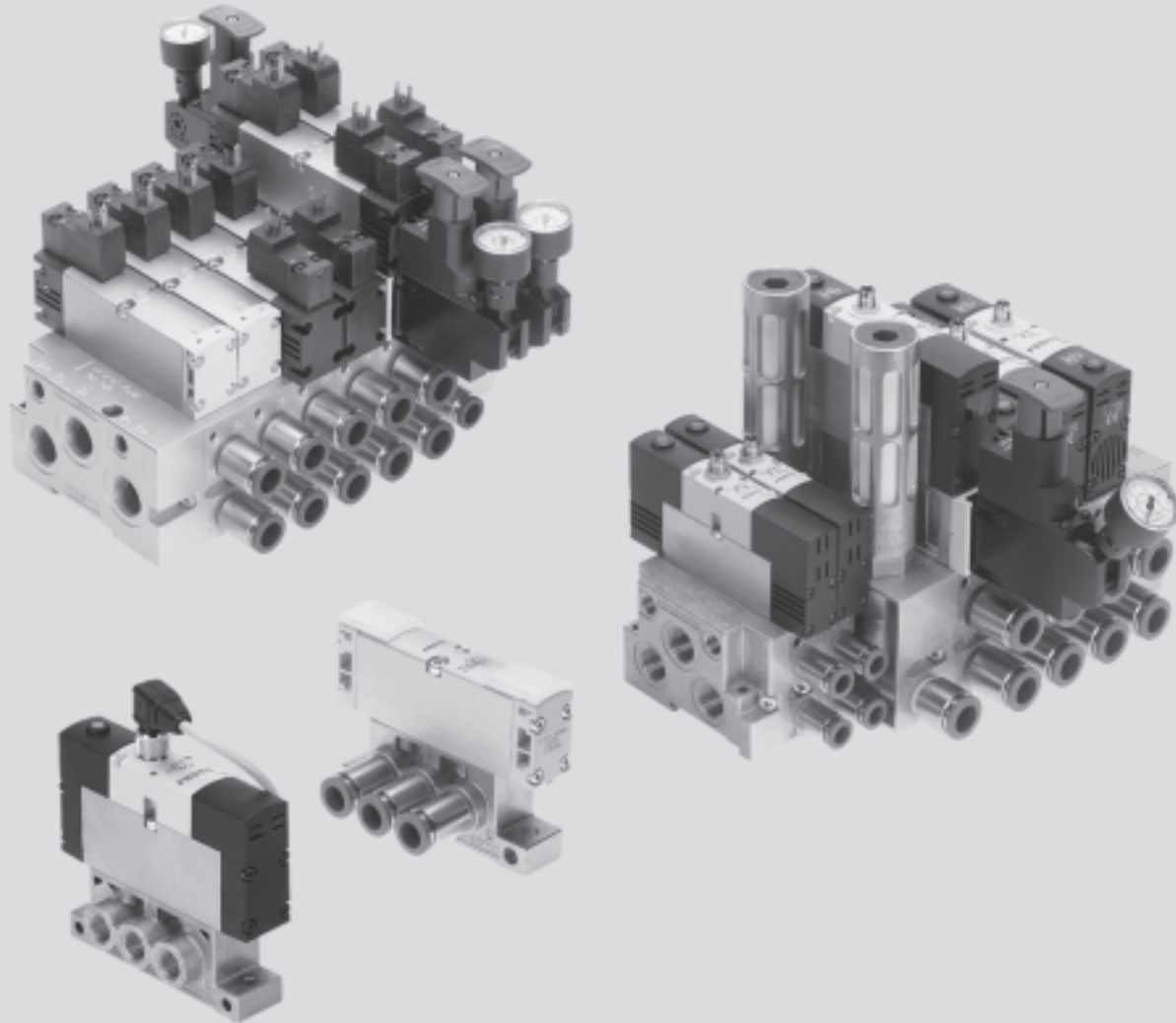

Innovative

- High-performance valves in sturdy metal housing
- Individual electrical connection via square plug sockets or centrally for each valve via round plug sockets
- Valve replacement under pressure possible using vertical isolating plate
- Reverse operation
- Vacuum operation

Flexible

- Modular system offering a range of configuration options
- Conversions and extensions are possible at any time
- Integration of innovative function modules possible
 - Pressure regulator plate
 - Flow control plate
 - Vertical isolating plate
 - Vertical supply plate
- Vertical supply plates permit a flexible air supply and variable pressure zones
- Wide range of valve functions
- Extensive operating voltage range from 12 V DC to 230 V AC

Reliable

- Sturdy and durable metal components
 - Valves
 - Horizontal stacking plates
 - Vertical stacking plates
- Fast troubleshooting thanks to LED in the plug socket or illuminating seal
- LED integrated in the valve with the round plug variant
- Reliability of service thanks to valves that can be replaced easily and quickly
- Manual override
- Durable thanks to the use of tried-and-tested piston spool valves

Easy to mount

- Secure wall mounting or H-rail mounting
- Combi manifolds of width 18 mm and 26 mm
- Plug-in pressure gauges on the pressure regulator

Solenoid valves VSVA, ISO 15407-1

Key features

FESTO

Individual valve manifold

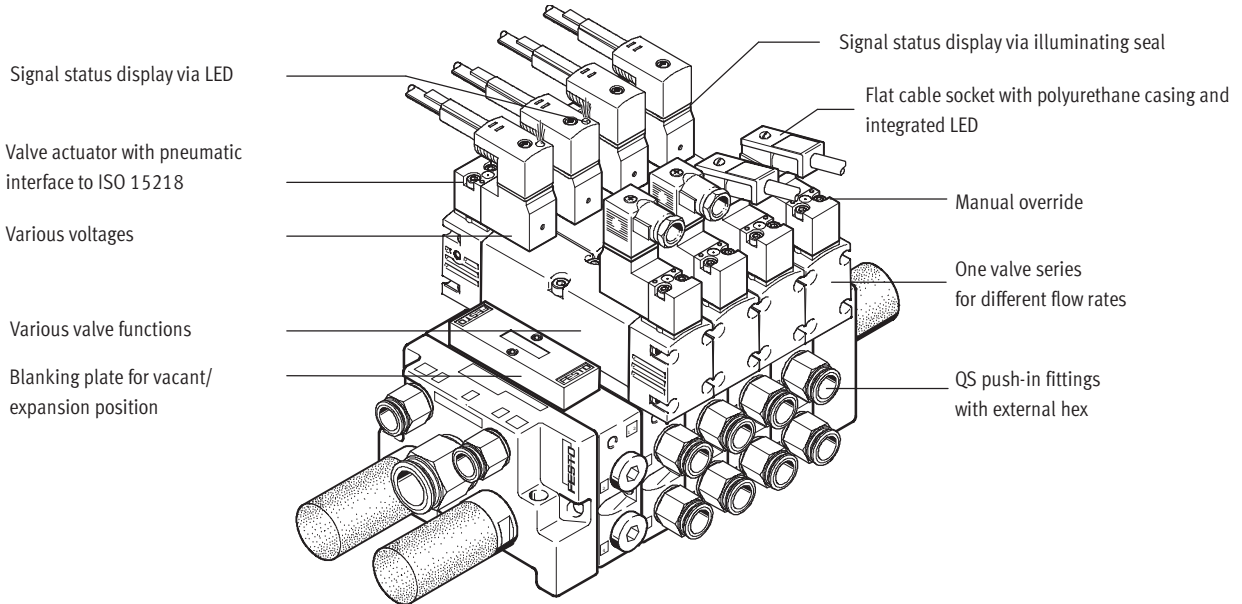

Equipment options

5/2-way valve	2x 3/2-way valve, single solenoid		5/3-way valve, single solenoid
<ul style="list-style-type: none"> • Single solenoid, pneumatic or spring return • Bistable, double solenoid valve • Bistable, double solenoid valve with dominance at 14 	<ul style="list-style-type: none"> • Normally open • Normally open, reversible (on request) • Normally closed • Normally closed, reversible (on request) 	<ul style="list-style-type: none"> • 1x normally open, 1x normally closed • 1x normally open, 1x normally closed, reversible (on request) 	<ul style="list-style-type: none"> • Mid-position valve <ul style="list-style-type: none"> – Normally open – Normally closed – Normally exhausted

Special features

<p>Operation with external pilot air</p> <ul style="list-style-type: none"> • For vacuum applications • For working pressures lower than 3 bar • For pressure fluctuations in the power section. Power section and pneumatic control section are decoupled • For strongly lubricated air in the power section • For manifolds if the pressure zones are created via ducts 3 and 5 (not possible with 2x 3/2) • For manifolds or pressure zones that are equipped with reversible 2x 3/2-way valves 	<p>Operation with internal pilot air</p> <ul style="list-style-type: none"> • For small pressure fluctuations in the power section • For using pressure regulator plates in a vertical stacking construction, also in reverse operation • As a low-cost solution 	<p>Reverse operation with pressure supply via ducts 3 and 5</p> <ul style="list-style-type: none"> • Pressure zone separation via ducts 3 and 5 <ul style="list-style-type: none"> – Example: Duct 3 vacuum, duct 5 ejector pulse – Example: Duct 3 high pressure for advancing the piston rod of a double-acting cylinder. Duct 5 low pressure for retracting the piston rod with low energy consumption • 2x 3/2-way valves used as 5/4-way valve with controllable overlapping with the reversible variant 	<p>Reverse operation with a pressure regulator plate, compressed air supply via duct 1</p> <ul style="list-style-type: none"> • Reversible pressure regulator combined with a reversible 2x 3/2-way valve regulates outputs 2 and 4 <ul style="list-style-type: none"> – AB regulator for outputs 2 and 4 – A regulator for output A – B regulator for output 2 • Reversible pressure regulators are in the control position immediately after the power supply is switched on <ul style="list-style-type: none"> – Adjustment possible at all times – Dynamic response characteristics – Reduced regulator load because the supply pressure is maintained when the valve is switched – Venting not via the regulator
---	--	---	---

Solenoid valves VSVA, ISO 15407-1

Key features



Valve manifold with combination of sizes and vertical stacking

Solenoid valve with individual valve actuators and pneumatic interface to ISO 15218. Can be connected with square plug sockets

Widths of 18 mm and 26 mm can be combined

Solenoid valve with central round plug

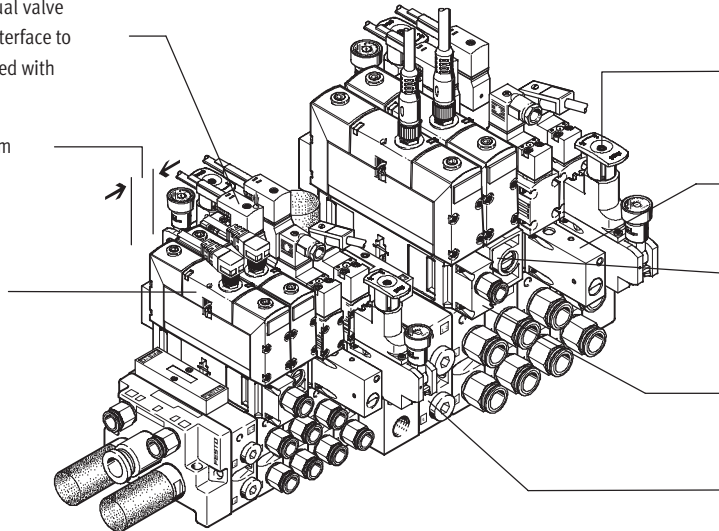

Pressure regulator for adjusting the force of the actuated drive

Pressure shut-off plate for solenoid valve replacement during operation

Flow control plate in the valve manifold for adjusting the speed of the drive

Supply plate for compressed air supply of a control chain as a separate pressure zone

Intermediate plate as interface between width 18 mm and width 26 mm

Vertical stacking function

Pressure regulator

- Single variant to regulate the pressure at output 4(A) or 2(B) or at input 1(P)
- Dual variant to regulate the pressure at output 4(A) and 2(B) individually
- Reverse variant for the outputs so that the regulator is in the control position
- With pressure gauge connection

Flow control plate

- Designed with two flow control valves, on which the exhaust air flow rate at exhausts 5 or 3 can be adjusted. The movement of the drive can thus be initiated and the desired speed set on the manifold using the manual override

Vertical shut-off plate

- Equipped with a switch via which the compressed air supply can be shut off. A directional control valve or subsequent vertical stacking plate can thus be replaced without switching off the overall air supply
- If the control chain has a redundant connection, the cycle can continue in the case of a cyclical control system

Vertical supply plate

- As additional air supply for one valve
- To supply a third pressure zone

Individual connection with square plug, type C

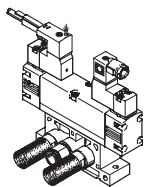

The directional control valve has a pilot control to ISO 15218 and a plug pattern to DIN EN 175301-803, type C.

Individual connection with central round plug

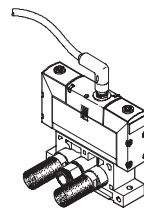

The electrical connection is established using a standardised 4-pin M12 or M8 socket 24 V DC (EN 61076-2-101).

Solenoid valves VSVA, ISO 15407-1

Key features

Individual valve manifold, directional control valves with square plug, type C

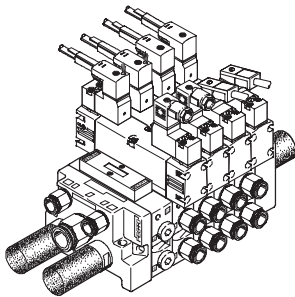

- Variant
- Width 26 mm
 - Vacant position
 - Compressed air supply via duct 1
 - External pilot air supply
 - QS push-in fittings
 - Venting via silencer for ducts 3 and 5

Individual valve manifold, pressure zones via ducts 3 and 5

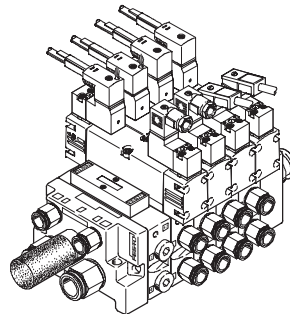

- Variant
- Width 26 mm
 - Vacant position
 - Compressed air supply via ducts 3 and 5
 - External pilot air supply
 - QS push-in fittings
 - Venting via silencer

Valve manifold equipped with width 18 mm and 26 mm, directional control valves with square plug, type C

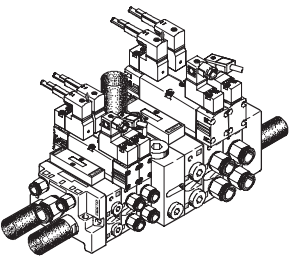

- Variant
- Width 18 mm and 26 mm combined via intermediate plate
 - Vacant positions
 - Compressed air supply via duct 1
 - External pilot air supply
 - QS push-in fittings
 - Venting via silencer for ducts 3 and 5 on the end plates and also on the intermediate plate

Valve manifold equipped with width 18 mm and 26 mm, directional control valves with central round plug

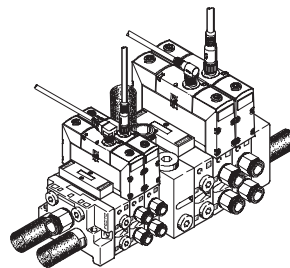

- Variant
- Width 18 mm and 26 mm combined via intermediate plate
 - Vacant positions
 - Compressed air supply via duct 1
 - Internal pilot air supply
 - QS push-in fittings
 - Venting via silencer for ducts 3 and 5 on the end plates and for duct 3 also on the intermediate plate

Maximum valve manifold expansion with all vertical stacking components

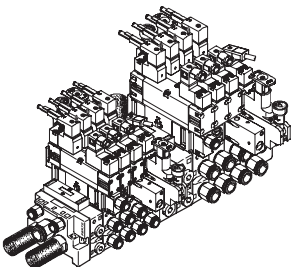

- Variant
- Width 18 mm and 26 mm combined via intermediate plate
 - Directional control valves with square plug
 - Pressure regulators
 - Flow control plates
 - Pressure shut-off plates
 - Supply plates with vacant position

Individual valve manifold with cable routing in one direction

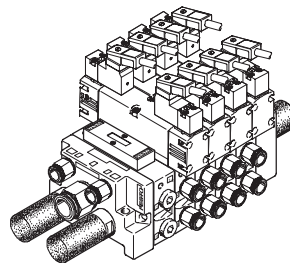

- Variant
- Width 26 mm
 - Solenoid coils 220 V DC
 - Plug socket with cable KMEB-2 – With plug socket with cable KMEB-1 the outgoing direction of the cable cannot be chosen with AC coils

Pneumatically actuated directional control valve on individual sub-base

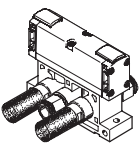

Directional control valves on an individual sub-base can be used for drives that are further away from a valve manifold or when there is only one drive available.

Valve manifold equipped with width 18 mm and 26 mm with pneumatically actuated directional control valves

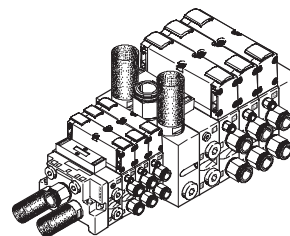

- Variant
- Width 18 mm and 26 mm combined via intermediate plate
 - Vacant positions
 - Compressed air supply via duct 1
 - QS push-in fittings
 - Venting via silencer for ducts 3 and 5 on the end plates and for ducts 3 and 5 also on the intermediate plate

Solenoid valves VSVA, ISO 15407-1

Key features



Solenoid valves with square plug, type C

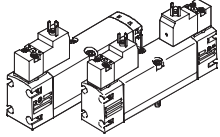

Variants

- Width 18 and 26 mm
- 2x 3/2-way, 5/2-way and 5/3-way valves
- 2x 3/2-way valves for reverse operation
- Internal or external pilot air supply available
- 12, 24 V DC, 24, 110 or 220 V AC available

Solenoid valves with central round plug

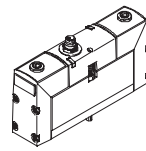

Variants

- Width 18 and 26 mm
- 2x 3/2-way, 5/2-way and 5/3-way valves
- Internal or external pilot air supply available
- 24 V DC

Basic valves with interface to ISO 15218

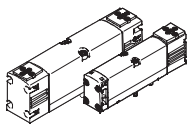

Variants

- Width 18 and 26 mm
- 2x 3/2-way, 5/2-way and 5/3-way valves
- Internal or external pilot air supply available

Valve actuator with interface to ISO 15218

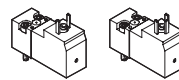

Variants

- For 12, 24 V DC and 24 V AC without protective earth conductor
- For 110 and 220 V AC with protective earth conductor
- 3/2-way valve
- Manual override, non-detenting

Pneumatically actuated directional control valves

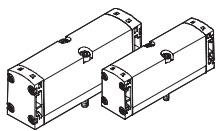

Variants

- Width 18 and 26 mm
- 2x 3/2-way, 5/2-way and 5/3-way valves
- Signal inputs 12 and 14 via the sub-base

Individual sub-base

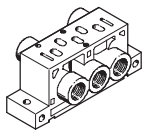

Variants

- Width 18 and 26 mm
- Ports 12 and 14 for external pilot air supply for solenoid valves and
- Ports signal inputs 12 and 14 for pneumatically actuated valves are the same

Blanking plate for vacant positions

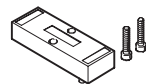

Variants

- Width 18 and 26 mm

End plate kit

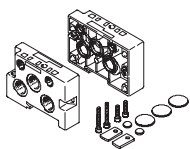

Variants

- Width 18 mm and 26 mm
- Ports 12 and 14 for external pilot air supply for solenoid valves
- For pneumatically actuated valves the signal inputs are only on the manifold sub-base suitable for this purpose

Manifold sub-base/series sub-base

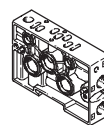

Variants

- Width 18 mm and 26 mm
- For solenoid valves
- For pneumatically actuated valves with additional ports for the signal inputs

Intermediate plate

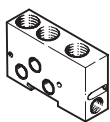

Variants

- Adapter between width 18 mm and 26 mm
- With additional air supply port and exhaust ports

Intermediate plate kit

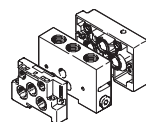

Variants

- Intermediate plate as adapter between width 18 mm and 26 mm
- One 18 mm and one 26 mm end plate

Solenoid valves VSVA, ISO 15407-1

Key features

Pressure regulator plate with pressure regulator

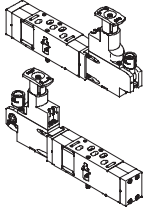

Variants

- Width 18 mm and 26 mm
- For pressure regulation on the supply input 1(P). Set pressure is the same for output 2 and 4
- For pressure regulation on the working port 4 (A)
 - The pressure regulators for reverse operation are supplied via port 1 of the sub-base and supply port 5 on the directional control valve
 - The directional control valve vents via port 1 to port 3 and 5 of the sub-base
- For pressure regulation on the working port 2 (B)
 - In reverse operation input 3 is supplied here

Pressure regulator plate with pressure regulators

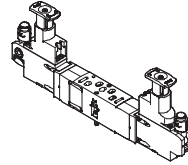

Variants

- Width 18 mm and 26 mm
- For pressure regulation on the working ports 4 (A) and 2 (B)
 - The pressure regulators for reverse operation are supplied via port 1 of the sub-base and supply inputs 5 and 3 on the directional control valve
 - The directional control valve vents via port 1 to port 3 and 5 of the sub-base

Vertical supply plate

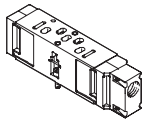

Variants

- Width 18 mm and 26 mm
- As intermediate supply
 - For one valve
 - To supply a third pressure zone
- Can be equipped with a directional control valve

Flow control plate

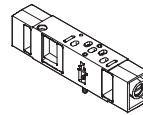

Variants

- Width 18 mm and 26 mm
- Exhaust air restriction in ducts 3 and 5
 - For pressure zones that are formed via ducts 3 and 5 the flow control plates function as supply air restrictors

Vertical isolating plate

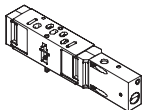

Variants

- Width 18 mm and 26 mm
- A switch activated with a slotted head screwdriver shuts off duct 1
 - The overlying flow control plates, pressure regulator plates or directional control valves can be replaced
 - Other components of the control chain such as drives, for example, can be replaced following venting via the directional control valve

Pressure gauge



Variant

- Can be connected to the pressure regulator plates

Solenoid valves VSVA, ISO 15407-1

Product range overview

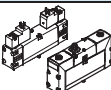
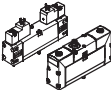
Function	Variant	Type	Flow rate of valve	Working port on sub-base		Operating voltage					
						[V DC]		[V AC]			
						[l/min]	G ¹ / ₈	G ¹ / ₄	12	24	24
2x 3/2-way valves in one housing	Width 18 mm, single solenoid valve										
		VSVA-B-T32...A2...C...	550	■	-	■	■	■	■	■	■
		VSVA-B-T32...A2...R...	550	■	-	-	■	-	-	-	-
	Width 26 mm, single solenoid valve										
		VSVA-B-T32...A1...C...	1,250	-	■	■	■	■	■	■	■
		VSVA-B-T32...A1...R...	1,250	-	■	-	■	-	-	-	-

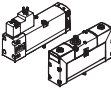
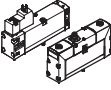
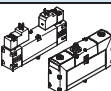
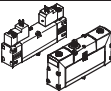
Function	Variant	Type	Flow rate of valve	Working port on sub-base		Operating voltage					
						[V DC]		[V AC]			
						[l/min]	G ¹ / ₈	G ¹ / ₄	12	24	24
5/2-way valve, single solenoid	Width 18 mm, single solenoid valve										
		VSVA-B-M52...A2...C...	700	■	-	■	■	■	■	■	■
		VSVA-B-M52...A2...R...	700	■	-	-	■	-	-	-	-
	Width 26 mm, single solenoid valve										
		VSVA-B-M52...A1...C...	1,400	-	■	■	■	■	■	■	■
		VSVA-B-M52...A1...R...	1,400	-	■	-	■	-	-	-	-
5/2-way valve, double solenoid	Width 18 mm, double solenoid valve										
		VSVA-B-B52...A2...C...	700	■	-	■	■	■	■	■	■
		VSVA-B-B52...A2...R...	700	■	-	-	■	-	-	-	-
	Width 26 mm, double solenoid valve										
		VSVA-B-B52...A1...C...	1,400	-	■	■	■	■	■	■	■
		VSVA-B-B52...A1...R...	1,400	-	■	-	■	-	-	-	-

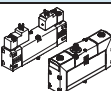
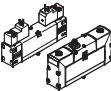
Function	Variant	Type	Flow rate of valve	Working port on sub-base		Operating voltage					
						[V DC]		[V AC]			
						[l/min]	G ¹ / ₈	G ¹ / ₄	12	24	24
5/3-way valve, monostable	Width 18 mm, mid-position valve										
		VSVA-B-P53...A2...C...	650	■	-	■	■	■	■	■	■
		VSVA-B-P53...A2...R...	650	■	-	-	■	-	-	-	-
	Width 26 mm, mid-position valve										
		VSVA-B-P53...A1...C...	1,400	-	■	■	■	■	■	■	■
		VSVA-B-P53...A1...R...	1,400	-	■	-	■	-	-	-	-

Solenoid valves VSVA, ISO 15407-1

Product range overview

Type	Plug			Pilot air		Spring return, pneumatic	Normal position			→ Page
	Square	Central round		Internal	External		2x closed	2x open	1x open 1x closed	
	MEB	M8x1	M12x1							
Width 18 mm, single solenoid valve										
VSVA-B-T32...A2...C...	■	-	-	■	■	■	■	■	■	2 / 1.3-17
VSVA-B-T32...A2...R...	-	■	-	■	■	■	■	■	■	2 / 1.3-33
Width 26 mm, single solenoid valve										
VSVA-B-T32...A1...C...	■	-	-	■	■	■	■	■	■	2 / 1.3-25
VSVA-B-T32...A1...R...	-	■	■	■	■	■	■	■	■	2 / 1.3-38

Type	Plug			Pilot air supply		Spring return		Signal processing			→ Page
	Square	Central round		Internal	External	Pneumatic	Mechanical	Single solenoid	Double solenoid/dominance		
	MEB	M8x1	M12x1						1st signal	At 14	
Width 18 mm, single solenoid valve											
VSVA-B-M52...A2...C...	■	-	-	■	■	■	■	■	-	-	2 / 1.3-17
VSVA-B-M52...A2...R...	-	■	-	■	■	■	■	■	-	-	2 / 1.3-33
Width 26 mm, single solenoid valve											
VSVA-B-M52...A1...C...	■	-	-	■	■	■	■	■	-	-	2 / 1.3-25
VSVA-B-M52...A1...R...	-	■	■	■	■	■	■	■	-	-	2 / 1.3-38
Width 18 mm, double solenoid valve											
VSVA-B-B52...A2...C...	■	-	-	■	■	-	-	-	■	■	2 / 1.3-17
VSVA-B-B52...A2...R...	-	■	-	■	■	-	-	-	■	■	2 / 1.3-33
Width 26 mm, double solenoid valve											
VSVA-B-B52...A1...C...	■	-	-	■	■	-	-	-	■	■	2 / 1.3-25
VSVA-B-B52...A1...R...	-	■	■	■	■	-	-	-	■	■	2 / 1.3-38

Type	Plug			Pilot air supply		Normal position			→ Page
	Square	Central round		Internal	External	Closed	Exhausted	Open	
	MEB	M8x1	M12x1						
Width 18 mm, mid-position valve									
VSVA-B-P53...A2...C...	■	-	-	■	■	■	■	■	2 / 1.3-17
VSVA-B-P53...A2...R...	-	■	-	■	■	■	■	■	2 / 1.3-33
Width 26 mm, mid-position valve									
VSVA-B-P53...A1...C...	■	-	-	■	■	■	■	■	2 / 1.3-25
VSVA-B-P53...A1...R...	-	■	■	■	■	■	■	■	2 / 1.3-38

Solenoid valves VSVA, ISO 15407-1

Type codes

VSVA		B	T	32	C	A	Z	H	A1	1	C1	
Valve family												
VSVA	Standard valves ISO 15407-1/-2											
Valve type												
B	Sub-base valve											
Valve function												
M	Single solenoid											
B	Double solenoid											
D	Double solenoid with dominance at 14											
P	Monostable, mid-position											
T	2 single solenoid valves in one housing											
Connections / switching positions												
32	3/2-way valve											
52	5/2-way valve											
53	5/3-way valve											
Normal position												
C	Closed											
N	Code T with 2x closed, reverse operation											
U	Open											
F	Code T with 2x open, reverse operation											
E	Exhausted											
H	Code T with 1x open, 1x closed											
W	Code T with 1x open, 1x closed, reverse operation											
	Double solenoid valve											
Reset method												
A	Pneumatic spring											
M	Mechanical spring											
	Double solenoid valve											
Pilot air supply												
Z	External											
	Internal											
Manual override												
H	Pushing (non-detenting)											
Standard												
A1	ISO size 01, width 26 mm											
A2	ISO size 02, width 18 mm											
Operating voltage												
1	24 VDC											
1A	24 VAC											
2A	110 VAC											
3A	230 VAC											
5	12 VDC											
Electrical connection												
C1	Type C to DIN EN 175301-803											
R2	Central plug M8x1											
R5	Central plug M10x1											
Signal status display												
L	LED (integrated)											

Solenoid valves VSVA, ISO 15407-1

Peripherals overview

Port pattern on sub-base to ISO 15407-1

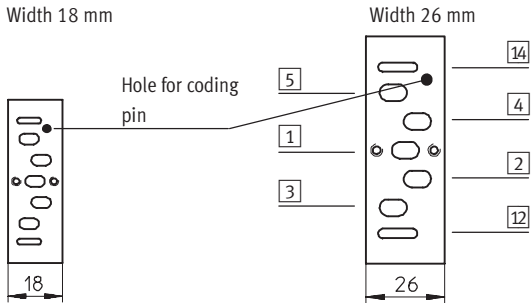

VSVA

Conversion of pilot air venting

VSVA valve manifolds are supplied with unducted ventilation of the pilot air. By turning the seal between the

valve and manifold block, ventilation can be diverted into the pilot duct 12

and it can thus be contained and silenced (see Figure).

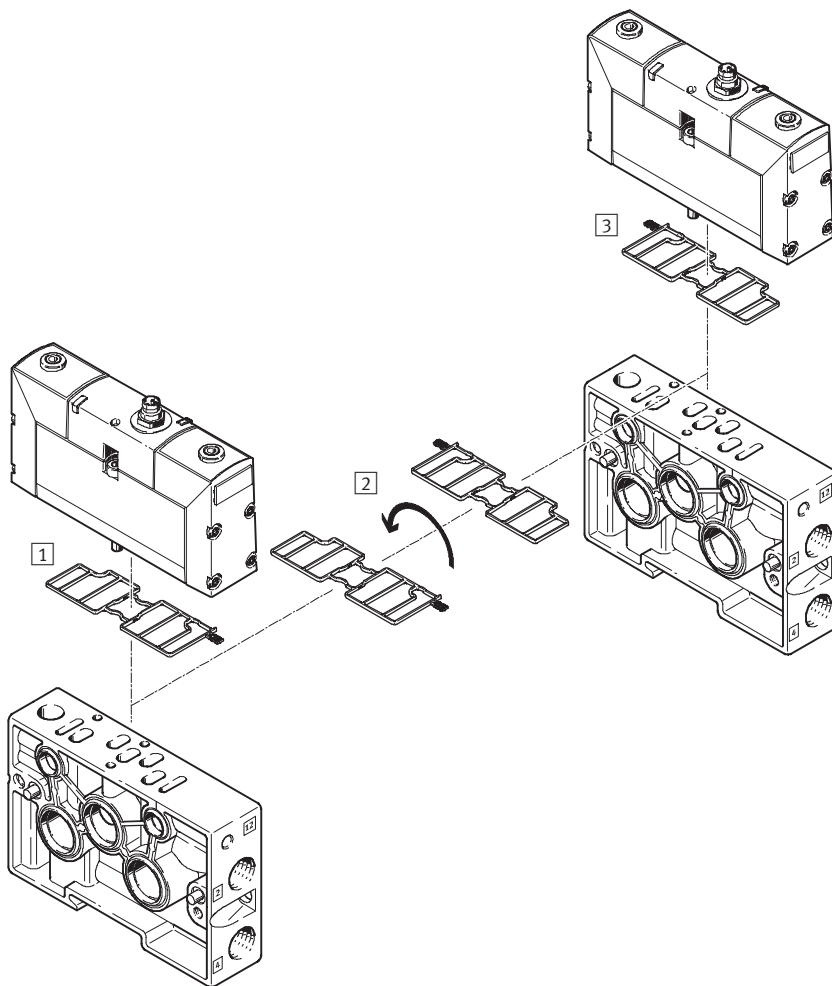

- 1 Ducted pilot air venting
- 2 Turning of seal by 180°
- 3 Unducted pilot air venting (as supplied)

Solenoid valves VSVA, ISO 15407-1

Peripherals overview

Individual mounting

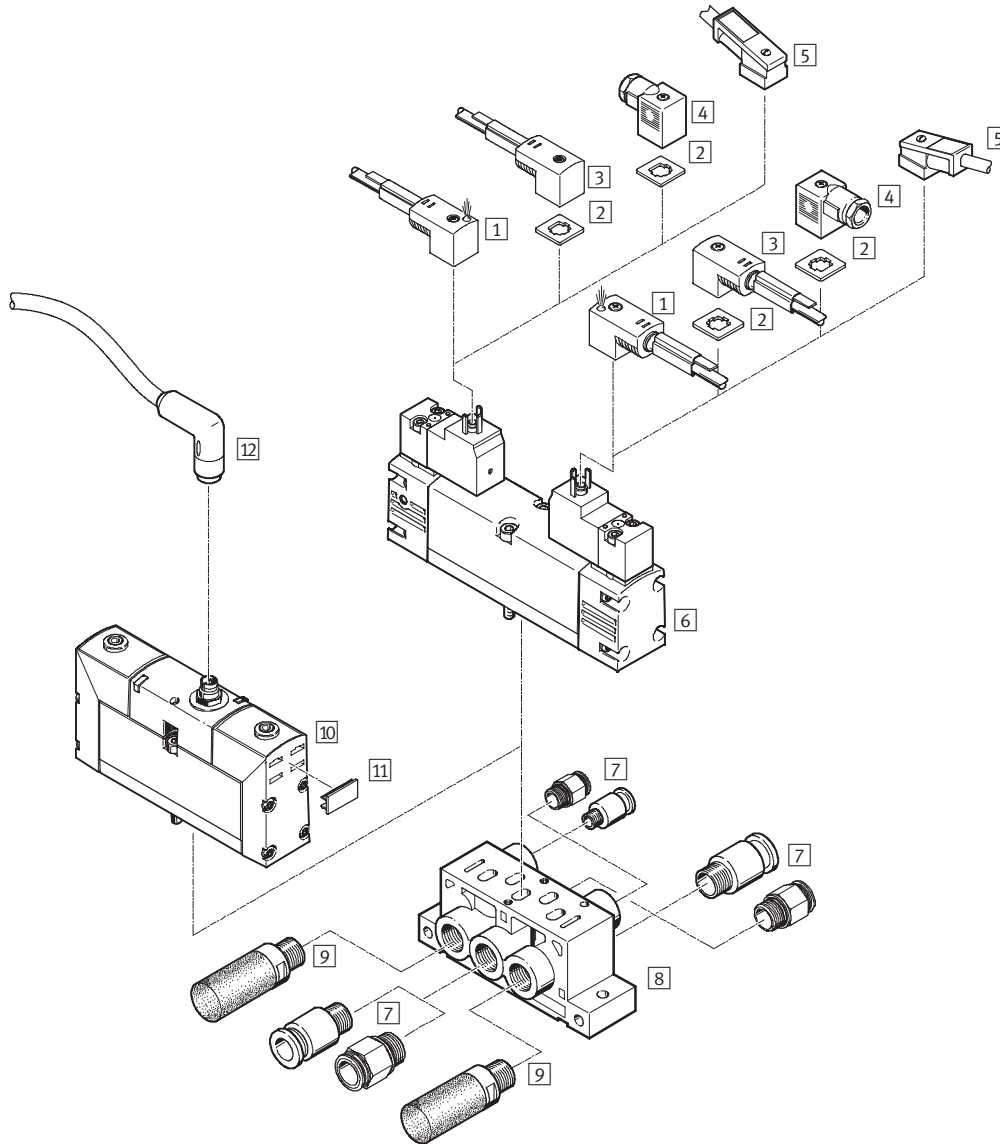

Standard directional control valves
ISO 15407-1

1.3

Component parts				
	Type	Brief description	→Page	
1	Plug socket with cable	KMEB1-...-LED	With PVC casing and LED	2 / 1.3-58
2	Illuminating seal	MEB-LD	For indicating the signal status	2 / 1.3-59
3	Plug socket with cable	KMEB1-...	With PVC casing	2 / 1.3-58
4	Plug socket	MSSD-EB	-	2 / 1.3-58
5	Plug socket with cable	KMEB2-...-LED	With polyurethane casing and LED	2 / 1.3-58
6	Solenoid valve	VSVA-...C-...	With interface to ISO 15218 and plug pattern type C	2 / 1.3-17
7	Push-in fitting	QS-...	For standard O.D. tubing	→ Volume 3
8	Individual sub-base	NAS-...	With lateral ports	2 / 1.3-43
9	Silencer	U-...	For fitting in exhaust ports	→ Volume 3
10	Solenoid valve	VSVA-...R-...	With round plug	2 / 1.3-17
11	Inscription labels	IBS-9x20	For identifying the VSVA valves with round plug	2 / 1.3-58
12	Plug socket with cable	SIM-...	For valves with round plug	2 / 1.3-59

Solenoid valves VSVA, ISO 15407-1

System overview

Manifold assembly

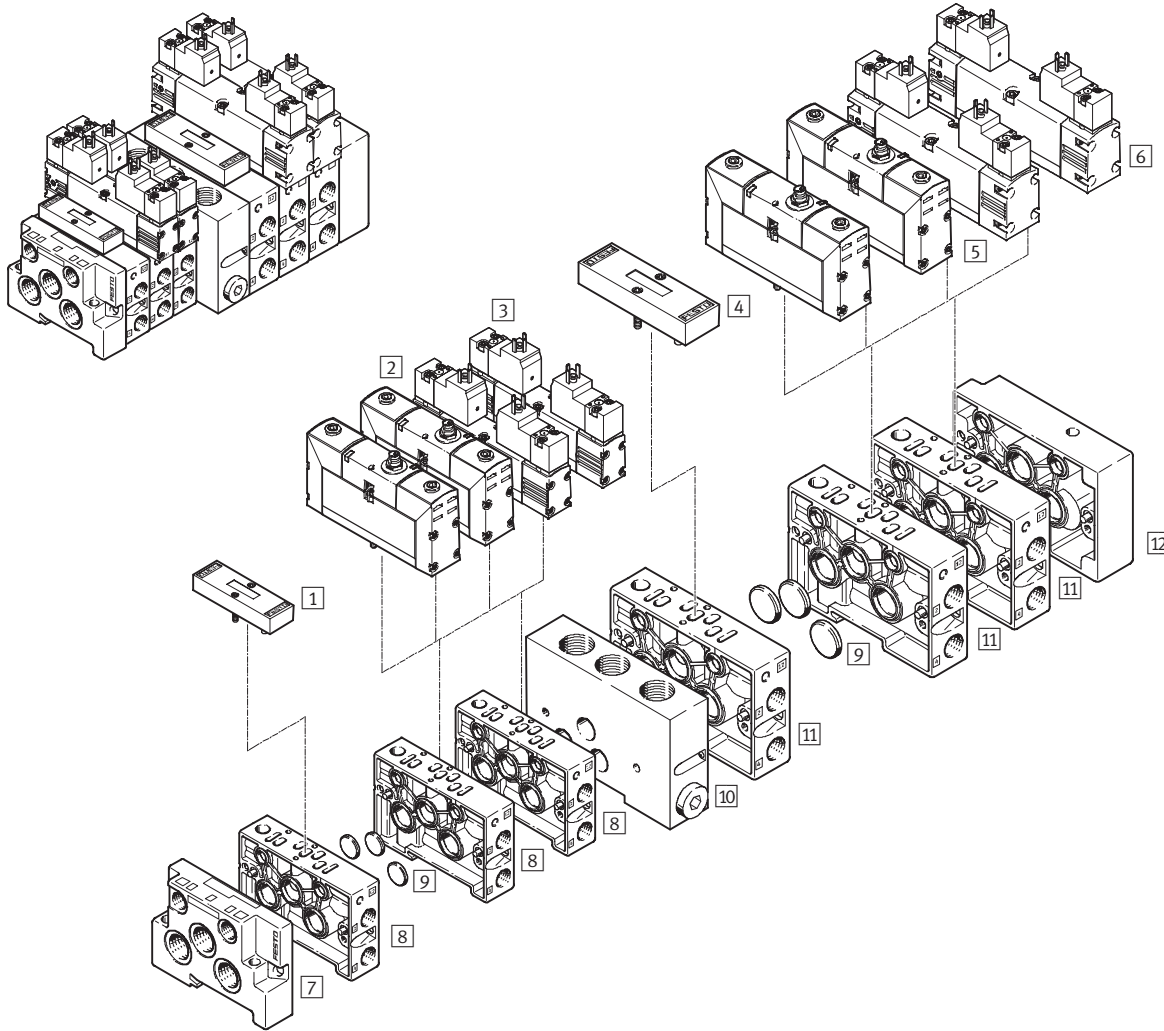

Component parts				
	Type	Brief description	→Page	
1	Blanking plate	NDV-02-VDMA	For width 18 mm, vacant or spare position	2 / 1.3-51
2	Solenoid valve	VSVA...A2...R...	Width 18 mm with round plug	2 / 1.3-33
3	Solenoid valve	VSVA...A2...C...	Width 18 mm with interface to ISO 15218 and plug pattern type C	2 / 1.3-17
4	Blanking plate	NDV-01-VDMA	For width 26 mm, vacant or spare position	2 / 1.3-51
5	Solenoid valve	VSVA...A1...R...	Width 26 mm with round plug	2 / 1.3-38
6	Solenoid valve	VSVA...A1...C...	Width 26 mm with interface to ISO 15218 and plug pattern type C	2 / 1.3-25
7	End plate	NEV-...	For sealing the manifold sub-bases width 18 mm	2 / 1.3-44
8	Manifold sub-base	NAW-1/8-02-VDMA	Width 18 mm with lateral ports 2 and 4	2 / 1.3-44
9	Isolating disc	NSC-...	For creating pressure zones or for sealing ports on the end plates	2 / 1.1-69
10	Intermediate plate	NZV-01/02-VDMA	For connecting width 18 mm with width 26 mm	2 / 1.3-45
11	Manifold sub-base	NAW-1/4-01-VDMA	Width 26 mm with lateral ports 2 and 4	2 / 1.3-44
12	End plate	NEV-...	For sealing the manifold sub-bases width 26 mm	2 / 1.3-44

Solenoid valves VSVA, ISO 15407-1

System overview

Manifold assembly with vertical stacking

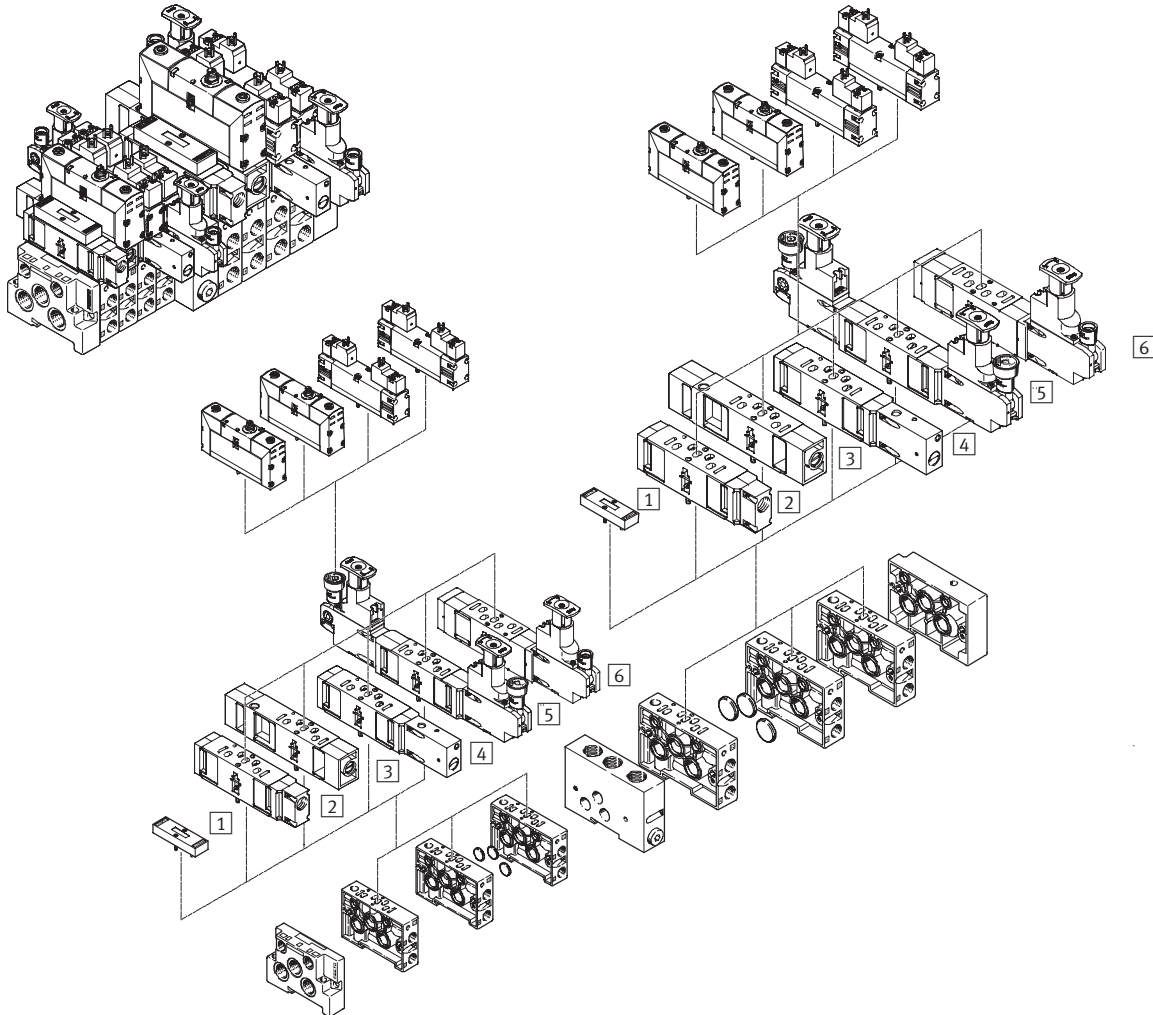

Component parts				
	Type	Brief description	→Page	
1	Blanking plate	NDV-...	For vacant or spare position	2 / 1.3-51
2	Vertical supply plate	VABF...P1-A3...	For intermediate air supply	2 / 1.3-56
3	Flow control plate	VABF...F1-B1...	For flow control in ducts 3 and 5	2 / 1.3-55
4	Vertical isolating plate	VABF...L1-D1...	With switch for manual shut-off of duct 1	2 / 1.3-57
5	Pressure regulator plate	VABF...R...-C2...	With 2 pressure regulators for working ports 2 and 4	2 / 1.3-52
6	Pressure regulator plate	VABF...R...-C2...	With a pressure regulator for working ports 2 or 4 or for duct 1	2 / 1.3-52

Solenoid valves VSVA, ISO 15407-1

Peripherals overview

Manifold assembly, valves with square plug

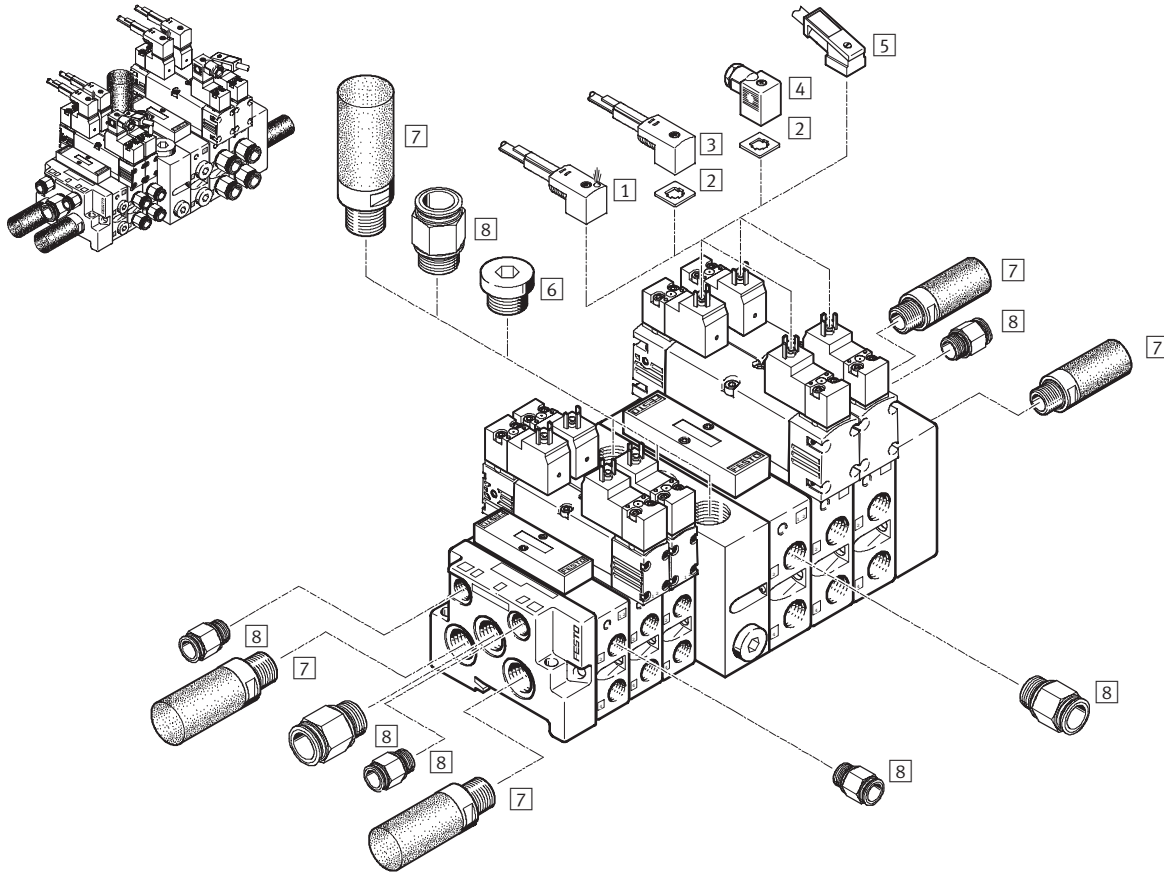

Component parts				
	Type	Brief description	→Page	
1	Plug socket with cable	KMEB1-...-LED	With PVC casing and LED	2 / 1.3-58
2	Illuminating seal	MEB-LD	For indicating the signal status	2 / 1.3-59
3	Plug socket with cable	KMEB1-...	With PVC casing	2 / 1.3-58
4	Plug socket	MSSD-EB	-	2 / 1.3-58
5	Plug socket with cable	KMEB2-...-LED	With polyurethane casing and LED	2 / 1.3-58
6	Blanking plug	B-...	For sealing unused ports	2 / 1.3-58
7	Silencer	U-...	For fitting in exhaust ports	→ Volume 3
8	Push-in fitting	QS-...	For standard O.D. tubing	→ Volume 3

Solenoid valves VSVA, ISO 15407-1

Peripherals overview

Manifold assembly, valves with central plug

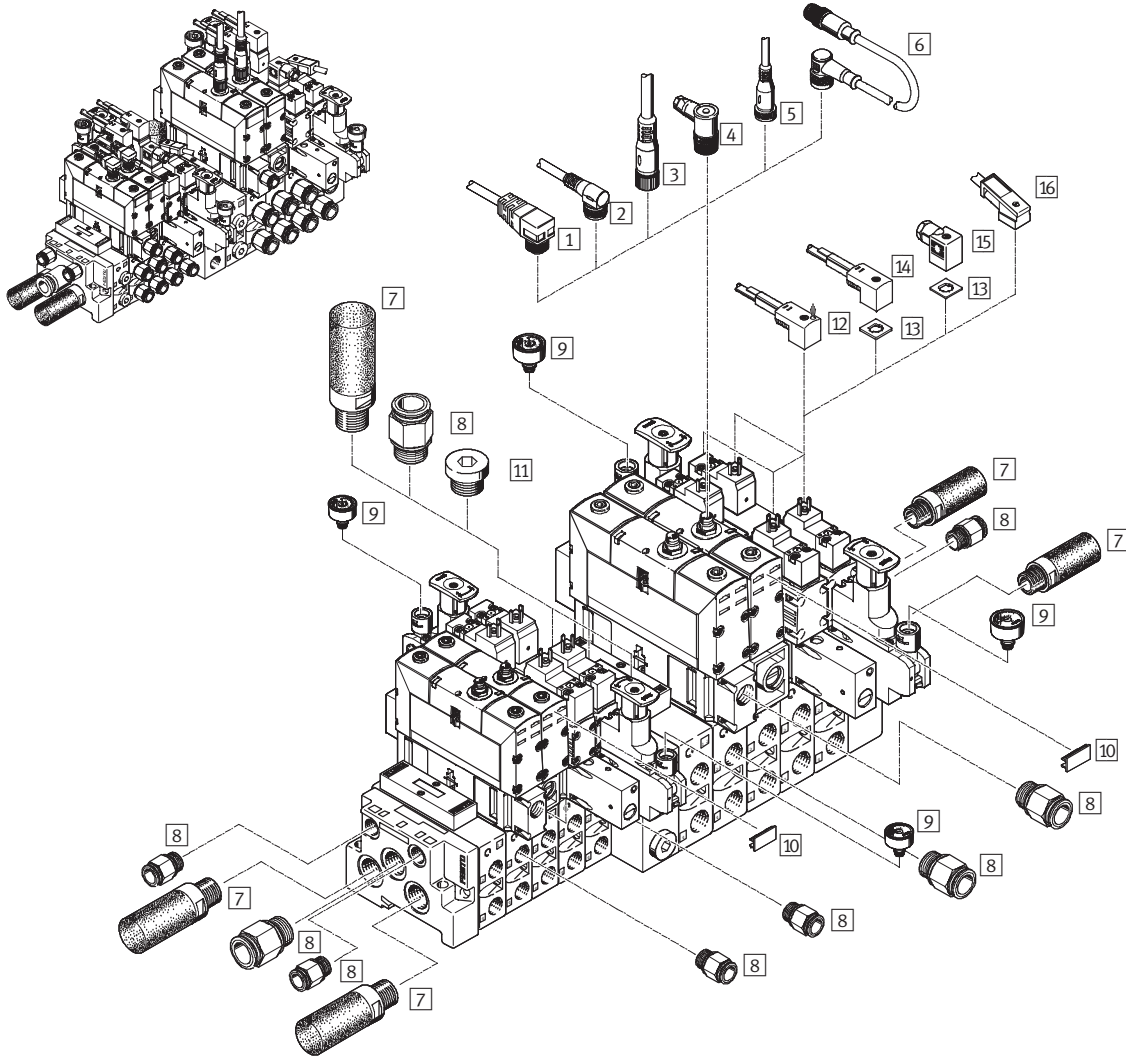

Standard directional control valves
ISO 15407-1

1.3

Component parts		Type	Brief description	→ Page
1	Plug socket with cable	SIM-M12-4-WD...	Angled plug socket	2 / 1.3-59
2	Plug socket with cable	SIM-M8-4-WD...	Angled plug socket	2 / 1.3-59
3	Plug socket with cable	SIM-M12-4-GD...	Straight plug socket	2 / 1.3-59
4	Plug socket	SEA-M12-4WD...	Angled	2 / 1.3-59
5	Plug socket with cable	SIM-M8-4-GD...	Straight plug socket	2 / 1.3-59
6	Connecting cable	KM-12-M12-...	Angled socket, straight plug	2 / 1.3-59
7	Silencer	U-...	For fitting in exhaust ports	→ Volume 3
8	Push-in fitting	QS-...	For standard O.D. tubing	→ Volume 3
9	Pressure gauge	PAGN-26-10-P10	Can be connected to the pressure regulator plate	2 / 1.3-58
10	Inscription labels	IBS-9x20	For identifying the VSVA valves with round plug	2 / 1.3-58
11	Blanking plug	B-...	For sealing unused ports	2 / 1.3-58
12	Plug socket with cable	KMEB1-...-LED	With PVC casing and LED	2 / 1.3-58
13	Illuminating seal	MEB-LD-...	For indicating the signal status	2 / 1.3-59
14	Plug socket with cable	KMEB1-...	With PVC casing	2 / 1.3-58
15	Plug socket	MSSD-EB	-	2 / 1.3-58
16	Plug socket with cable	KMEB2-...-LED	With polyurethane casing and LED	2 / 1.3-58

Solenoid valves VSVA, ISO 15407-1/plug type C

Technical data – Directional control valves width 18 mm

 Flow rate
550 ... 700 l/min

 Voltage
12, 24 V DC
24, 110, 230 V AC

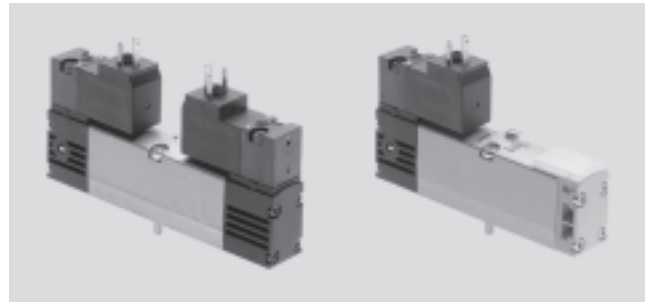

General technical data						
Valve function	2x 3/2			5/2		5/3
Normal position	C ¹⁾ , N ⁵⁾	U ²⁾ , F ⁶⁾	H ⁴⁾ , W ⁷⁾	–	–	C ¹⁾ , U ²⁾ , E ³⁾
Memory stability	Monostable				Bistable	Monostable
Pneumatic spring reset method	Yes			Yes	–	No
Mechanical spring reset method	No			Yes	–	Yes
Design	Piston spool valve					
Sealing principle	Soft					
Actuation type	Electrical					
Control type	Piloted					
Pilot interface	To ISO 15218					
Pilot air supply	Internal or external					
Direction of flow	Non-reversible			Reversible for external pilot air supply		
Exhaust function	With flow control					
Manual override	Pushing (non-detenting)					
Type of mounting	On individual/manifold sub-base					
Mounting position	Any					
Nominal size	[mm]	5				
Flow rate of valve	[l/min]	550		700	650	
Flow rate of valve on individual sub-base	[l/min]	500		600	550	
Flow rate of valve on manifold sub-base	[l/min]	400		550	450	
Standard nominal flow rate	[l/min]	400		550	450	
Switching time on/off, pneumatic spring	[ms]	13/21		21/19	–	–
Switching time on/off, mechanical spring	[ms]	–		17/35	–	18/30
Switching time on/off, for N, F and W	[ms]	21/13		–	–	–
Changeover time	[ms]	–		–	15	–
Freedom from overlap	Yes					
Width	[mm]	18				
Ports on the sub-base	1, 2, 3, 4, 5	G $\frac{1}{8}$				
	12, 14	M5				
Tightening torque, valve mounting	[Nm]	0.68 ... 0.92				
Product weight	[g]	174		127	174	
Noise level	[dB (A)]	85				
Conforms to	ISO 15407-1 and interface for valve actuator ISO 15218					
Corrosion resistance class	CRC	2 ⁸⁾				

1) C=Normally closed

2) U=Normally open

3) E=Normally exhausted

4) H=2x 3/2-way valves in one housing with 1x normally closed and 1x normally open

5) N=Normally closed, reverse operation, i.e. the pressure supply ports are 3 and 5, venting is via port 1

6) F=Normally open, reverse operation, i.e. the pressure supply ports are 3 and 5, venting is via port 1

7) W=2x 3/2-way valve in one housing with 1x normally closed and 1x normally open,

reverse operation, i.e. the pressure supply ports are 3 and 5, venting is via port 1

8) Corrosion resistance class 2 to Festo standard 940 070

Components subject to moderate corrosion stress. Externally visible parts with primarily decorative surface requirements which are in direct contact with a normal industrial environment or media such as coolants or lubricating agents

Solenoid valves VSVA, ISO 15407-1/plug type C

Technical data – Directional control valves width 18 mm

Operating and environmental conditions			2x 3/2	5/2	5/3
Valve function			2x 3/2	5/2	5/3
Operating medium			Filtered compressed air, grade of filtration 40µm, lubricated or unlubricated		
Operating pressure	Internal pilot air supply	[bar]	2 ... 10		3 ... 10
	External pilot air supply	[bar]	2 ... 10	-0.9 ... 10	
Pilot pressure with pneumatic spring		[bar]	2 ... 10 ¹⁾	2 ... 10	-
Pilot pressure with mechanical spring		[bar]	-	3 ... 10	3 ... 10
Ambient temperature		[°C]	-5 ... +50		
Temperature of medium		[°C]	-5 ... +50		
Fire protection classification to UL94			HB		

1) Pilot pressure dependent on operating pressure → Graph

Minimum pilot pressure p12, p14 as a function of the operating pressure p1 (external pilot air supply)

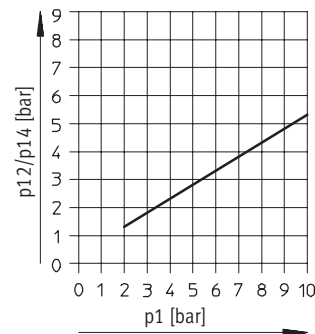

Electrical data			
Electrical connection			
		Plug, square design to DIN EN 175301-803, type C	
		12 V/24 V DC/AC without protective earth conductor	
		110 V/230 V AC with protective earth conductor	
Operating voltage	DC voltage	[V DC]	12, 24 +10%/-15%
	AC voltage	[V AC]	24, 110, 230 +10%/-15%
Coil characteristics	DC voltage	[W]	1.8
	AC voltage	[VA]	2.1 at 110 V/230 V, 2.3 at 24 V
Duty cycle		[%]	100
Protection class to EN 60529			IP65 (in combination with plug socket)
CE mark			73/23/EEC (low voltage)

Solenoid valves VSVA, ISO 15407-1/plug type C

Technical data – Directional control valves width 18 mm

Materials

Sectional view

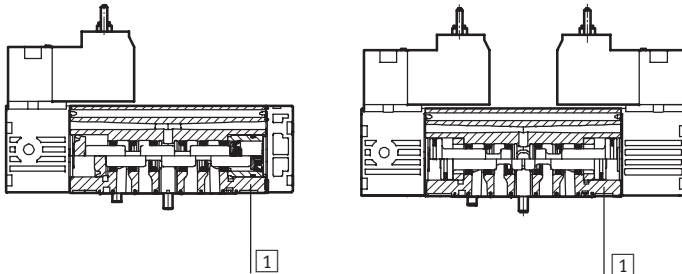

1	Housing	Die-cast aluminium
-	Seals	Nitrile rubber
-	Screws	Galvanised steel
-	Note on materials	Contains paint wetting impairment substances

Dimensions

Download CAD data → www.festo.com/en/engineering

5/2-way valve, single solenoid

1 Connection dimensions and device plug to DIN EN 175301-803, type C

2 Manual override

3 Captive screws

4 Slot for inscription label

	B1	B2	D1	H1	H2	H3	H4	H5	L1	L2	L3	L4	L5
VSVA-B-M52...	18	12.5	M3	80.6	62.2	53.6	30.3	5.4	95.4	53.9	21.25	53.1	102.2

Solenoid valves VSVA, ISO 15407-1/plug type C

Technical data – Directional control valves width 18 mm

Dimensions Download CAD data → www.festo.com/en/engineering

2x 3/2-way valve, 5/2-way valve, double solenoid, 5/3-way valve

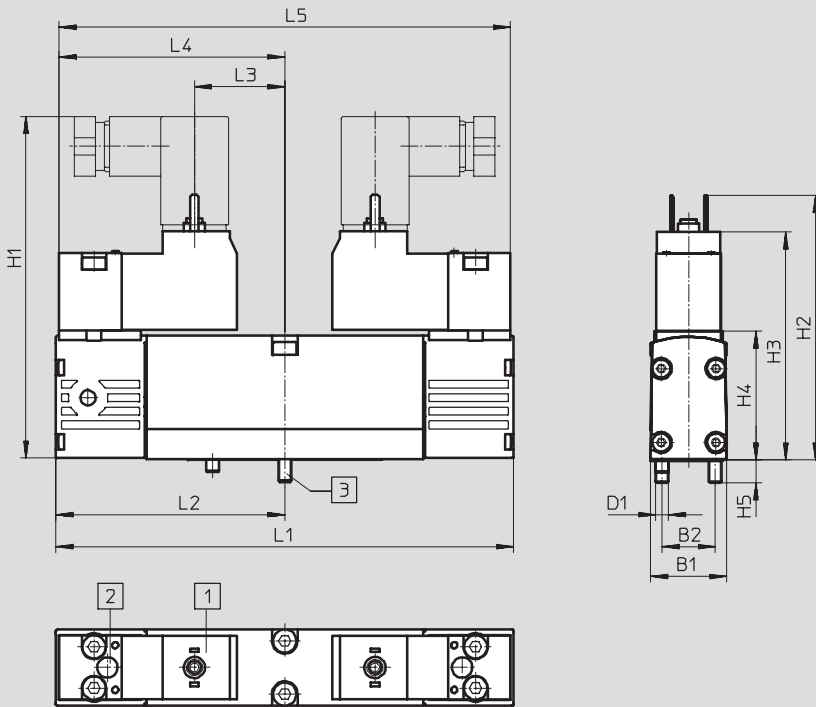

- 1 Connection dimensions and device plug to DIN EN 175301-803, type C
- 2 Manual override
- 3 Captive screws
- 4 Slot for inscription label

	B1	B2	D1	H1	H2	H3	H4	H5	L1	L2	L3	L4	L5
VSVA-B-M52...	18	12.5	M3	80.6	62.2	53.6	30.3	5.4	107.8	53.9	21.25	53.1	102.2

Dimensions Download CAD data → www.festo.com/en/engineering

5/2-way valve, double solenoid – valve actuator for widths 18 mm and 26 mm

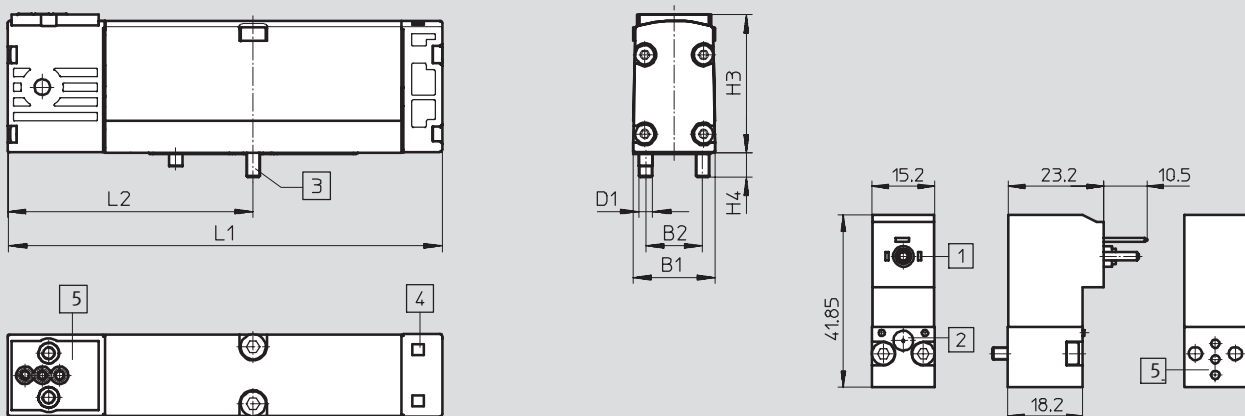

- 1 Connection dimensions and device plug to DIN EN 175301-803, type C
- 2 Manual override
- 3 Captive screws
- 4 Slot for inscription label
- 5 Pneumatic port pattern to ISO 15218

	B1	B2	D1	H4	H5	L1	L2
VSVA-B-M52...	18	12.5	M3	30.3	5.4	95.4	53.9

Solenoid valves VSVA, ISO 15407-1/plug type C

Technical data – Directional control valves width 18 mm

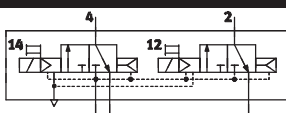
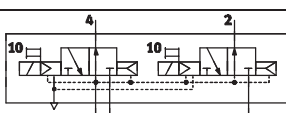
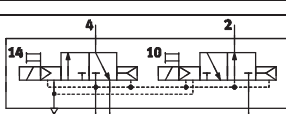
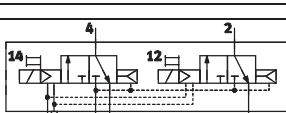
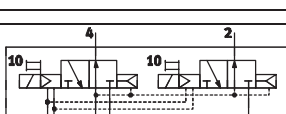
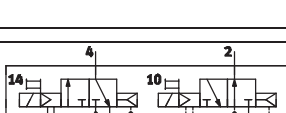
Ordering data – 2x 3/2-way valve ¹⁾						
Code	Circuit symbol	Normal position	Pilot air supply	Voltage		Part No. Type
				V DC	V AC	
K		2x closed	Internal	24	–	546 693 VSVA-B-T32C-AH-A2-1C1
				12	–	547 129 VSVA-B-T32C-AH-A2-5C1
				–	230	547 209 VSVA-B-T32C-AH-A2-3AC1
				–	110	547 169 VSVA-B-T32C-AH-A2-2AC1
				–	24	547 089 VSVA-B-T32C-AH-A2-1AC1
N		2x open	Internal	24	–	546 695 VSVA-B-T32U-AH-A2-1C1
				12	–	547 131 VSVA-B-T32U-AH-A2-5C1
				–	230	547 211 VSVA-B-T32U-AH-A2-3AC1
				–	110	547 171 VSVA-B-T32U-AH-A2-2AC1
				–	24	547 091 VSVA-B-T32U-AH-A2-1AC1
H		1x closed 1x open	Internal	24	–	547 067 VSVA-B-T32H-AH-A2-1C1
				12	–	547 133 VSVA-B-T32H-AH-A2-5C1
				–	230	547 213 VSVA-B-T32H-AH-A2-3AC1
				–	110	547 173 VSVA-B-T32H-AH-A2-2AC1
				–	24	547 093 VSVA-B-T32H-AH-A2-1AC1
K		2x closed	External	24	–	547 069 VSVA-B-T32C-AZH-A2-1C1
				12	–	547 149 VSVA-B-T32C-AZH-A2-5C1
				–	230	547 229 VSVA-B-T32C-AZH-A2-3AC1
				–	110	547 189 VSVA-B-T32C-AZH-A2-2AC1
				–	24	547 109 VSVA-B-T32C-AZH-A2-1AC1
N		2x open	External	24	–	547 071 VSVA-B-T32U-AZH-A2-1C1
				12	–	547 151 VSVA-B-T32U-AZH-A2-5C1
				–	230	547 231 VSVA-B-T32U-AZH-A2-3AC1
				–	110	547 191 VSVA-B-T32U-AZH-A2-2AC1
				–	24	547 111 VSVA-B-T32U-AZH-A2-1AC1
H		1x closed 1x open	External	24	–	547 073 VSVA-B-T32H-AZH-A2-1C1
				12	–	547 153 VSVA-B-T32H-AZH-A2-5C1
				–	230	547 233 VSVA-B-T32H-AZH-A2-3AC1
				–	110	547 193 VSVA-B-T32H-AZH-A2-2AC1
				–	24	547 113 VSVA-B-T32H-AZH-A2-1AC1

1) 2x 3/2-way valves for reverse operation on request

Solenoid valves VSVA, ISO 15407-1/plug type C

Technical data – Directional control valves width 18 mm

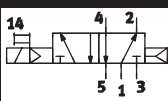
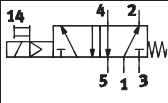
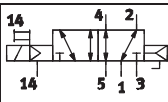
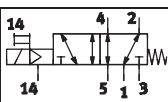
Ordering data – 5/2-way valve, single solenoid (monostable)							
Code	Circuit symbol	Reset method	Pilot air supply	Voltage		Part No.	Type
				V DC	V AC		
M		Pneumatic	Internal	24	–	546 701	VSVA-B-M52-AH-A2-1C1
				12	–	547 139	VSVA-B-M52-AH-A2-5C1
				–	230	547 219	VSVA-B-M52-AH-A2-3AC1
				–	110	547 179	VSVA-B-M52-AH-A2-2AC1
				–	24	547 099	VSVA-B-M52-AH-A2-1AC1
O		Mechanical spring	Internal	24	–	546 703	VSVA-B-M52-MH-A2-1C1
				12	–	547 141	VSVA-B-M52-MH-A2-5C1
				–	230	547 221	VSVA-B-M52-MH-A2-3AC1
				–	110	547 181	VSVA-B-M52-MH-A2-2AC1
				–	24	547 101	VSVA-B-M52-MH-A2-1AC1
M		Pneumatic	External	24	–	547 079	VSVA-B-M52-AZH-A2-1C1
				12	–	547 159	VSVA-B-M52-AZH-A2-5C1
				–	230	547 239	VSVA-B-M52-AZH-A2-3AC1
				–	110	547 199	VSVA-B-M52-AZH-A2-2AC1
				–	24	547 119	VSVA-B-M52-AZH-A2-1AC1
O		Mechanical spring	External	24	–	547 081	VSVA-B-M52-MZH-A2-1C1
				12	–	547 161	VSVA-B-M52-MZH-A2-5C1
				–	230	547 241	VSVA-B-M52-MZH-A2-3AC1
				–	110	547 201	VSVA-B-M52-MZH-A2-2AC1
				–	24	547 121	VSVA-B-M52-MZH-A2-1AC1

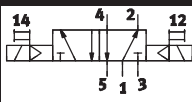
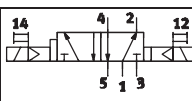
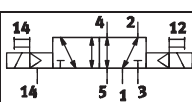
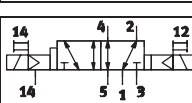
Ordering data – 5/2-way valve, double solenoid (bistable)							
Code	Circuit symbol	Dominance	Pilot air supply	Voltage		Part No.	Type
				V DC	V AC		
J		1st signal	Internal	24	–	546 697	VSVA-B-B52-H-A2-1C1
				12	–	547 135	VSVA-B-B52-H-A2-5C1
				–	230	547 215	VSVA-B-B52-H-A2-3AC1
				–	110	547 175	VSVA-B-B52-H-A2-2AC1
				–	24	547 095	VSVA-B-B52-H-A2-1AC1
D		At 14	Internal	24	–	546 699	VSVA-B-D52-H-A2-1C1
				12	–	547 137	VSVA-B-D52-H-A2-5C1
				–	230	547 217	VSVA-B-D52-H-A2-3AC1
				–	110	547 177	VSVA-B-D52-H-A2-2AC1
				–	24	547 097	VSVA-B-D52-H-A2-1AC1
J		1st signal	External	24	–	547 075	VSVA-B-B52-ZH-A2-1C1
				12	–	547 155	VSVA-B-B52-ZH-A2-5C1
				–	230	547 235	VSVA-B-B52-ZH-A2-3AC1
				–	110	547 195	VSVA-B-B52-ZH-A2-2AC1
				–	24	547 115	VSVA-B-B52-ZH-A2-1AC1
D		At 14	External	24	–	547 077	VSVA-B-D52-ZH-A2-1C1
				12	–	547 157	VSVA-B-D52-ZH-A2-5C1
				–	230	547 237	VSVA-B-D52-ZH-A2-3AC1
				–	110	547 197	VSVA-B-D52-ZH-A2-2AC1
				–	24	547 117	VSVA-B-D52-ZH-A2-1AC1

Solenoid valves VSVA, ISO 15407-1/plug type C

Technical data – Directional control valves width 18 mm

Ordering data – 5/3-way valve, double solenoid (monostable)						
Code	Circuit symbol	Normal position	Pilot air supply	Voltage		Part No. Type
				V DC	V AC	
G		Closed	Internal	24	–	546 709 VSVA-B-P53C-H-A2-1C1
				12	–	547 147 VSVA-B-P53C-H-A2-5C1
				–	230	547 227 VSVA-B-P53C-H-A2-3AC1
				–	110	547 187 VSVA-B-P53C-H-A2-2AC1
				–	24	547 107 VSVA-B-P53C-H-A2-1AC1
B		Open	Internal	24	–	546 705 VSVA-B-P53U-H-A2-1C1
				12	–	547 143 VSVA-B-P53U-H-A2-5C1
				–	230	547 223 VSVA-B-P53U-H-A2-3AC1
				–	110	547 183 VSVA-B-P53U-H-A2-2AC1
				–	24	547 103 VSVA-B-P53U-H-A2-1AC1
E		Exhausted	Internal	24	–	546 707 VSVA-B-P53E-H-A2-1C1
				12	–	547 145 VSVA-B-P53E-H-A2-5C1
				–	230	547 225 VSVA-B-P53E-H-A2-3AC1
				–	110	547 185 VSVA-B-P53E-H-A2-2AC1
				–	24	547 105 VSVA-B-P53E-H-A2-1AC1
G		Closed	External	24	–	547 087 VSVA-B-P53C-ZH-A2-1C1
				12	–	547 167 VSVA-B-P53C-ZH-A2-5C1
				–	230	547 247 VSVA-B-P53C-ZH-A2-3AC1
				–	110	547 207 VSVA-B-P53C-ZH-A2-2AC1
				–	24	547 127 VSVA-B-P53C-ZH-A2-1AC1
B		Open	External	24	–	547 083 VSVA-B-P53U-ZH-A2-1C1
				12	–	547 163 VSVA-B-P53U-ZH-A2-5C1
				–	230	547 243 VSVA-B-P53U-ZH-A2-3AC1
				–	110	547 203 VSVA-B-P53U-ZH-A2-2AC1
				–	24	547 123 VSVA-B-P53U-ZH-A2-1AC1
E		Exhausted	External	24	–	547 085 VSVA-B-P53E-ZH-A2-1C1
				12	–	547 165 VSVA-B-P53E-ZH-A2-5C1
				–	230	547 245 VSVA-B-P53E-ZH-A2-3AC1
				–	110	547 205 VSVA-B-P53E-ZH-A2-2AC1
				–	24	547 125 VSVA-B-P53E-ZH-A2-1AC1

Solenoid valves VSVA, ISO 15407-1/plug type C



Technical data – Directional control valves width 18 mm without valve actuators

Ordering data – 2x 3/2-way valve without valve actuator				
Design	Normal position	Pilot air supply	Part No.	Type
	2x closed	Internal	546 732	VSVA-B-T32C-A-A2-P1
	2x open	Internal	546 734	VSVA-B-T32U-A-A2-P1

Ordering data – 5/2-way valve, single solenoid (monostable) without valve actuator				
Design	Reset method	Pilot air supply	Part No.	Type
	Pneumatic	Internal	546 740	VSVA-B-M52-A-A2-P1
	Mechanical spring	Internal	546 742	VSVA-B-M52-M-A2-P1

Ordering data – 5/2-way double solenoid (bistable) valve without valve actuator				
Design	Dominance	Pilot air supply	Part No.	Type
	1st signal	Internal	546 736	VSVA-B-B52-A2-P1
	At 14	Internal	546 738	VSVA-B-D52-A2-P1

Ordering data – 5/3-way mid-position valve (monostable) without valve actuator				
Design	Normal position	Pilot air supply	Part No.	Type
	Closed	Internal	546 748	VSVA-B-P53C-A2-P1
	Open	Internal	546 744	VSVA-B-P53U-A2-P1
	Exhausted	Internal	546 746	VSVA-B-P53E-A2-P1

Ordering data – valve actuator to ISO 15218								
Design	Plug, square design	Protective earth conductor	Output		Voltage		Part No.	Type
			[W]	[VA]	V DC	V AC		
	DIN EN 175301-803, type C	No	1.8	–	24	–	546 256	VSCS-B-M32-MH-WA-1C1
		No	1.8	–	12	–	546 257	VSCS-B-M32-MH-WA-5C1
	DIN EN 175301-803, type C	Yes	–	2.1	–	230	546 260	VSCS-B-M32-MH-WA-3AC1
		Yes	–	2.1	–	110	546 259	VSCS-B-M32-MH-WA-2AC1
		No	–	2.3	–	24	546 258	VSCS-B-M32-MH-WA-1AC1

Solenoid valves VSVA, ISO 15407-1/plug type C

Technical data – Directional control valves width 26 mm



 Flow rate
1,250 ... 1,400 l/min

 Voltage
12, 24 V DC
24, 110, 230 V AC

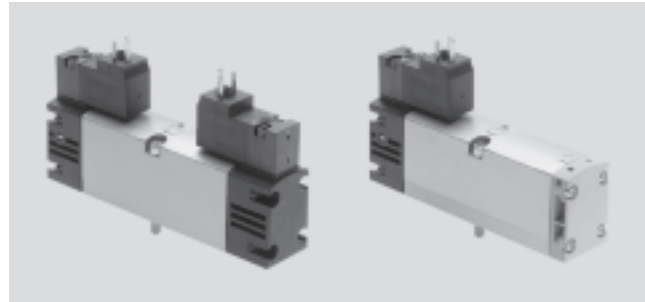

General technical data						
Valve function	2x 3/2			5/2		5/3
Normal position	C ¹⁾ , N ⁵⁾	U ²⁾ , F ⁶⁾	H ⁴⁾ , W ⁷⁾	–	–	C ¹⁾ , U ²⁾ , E ³⁾
Memory stability	Monostable				Bistable	Monostable
Pneumatic spring reset method	Yes			Yes	–	No
Mechanical spring reset method	No			Yes	–	Yes
Design	Piston spool valve					
Sealing principle	Soft					
Actuation type	Electrical					
Control type	Piloted					
Pilot interface	To ISO 15218					
Pilot air supply	Internal or external					
Direction of flow	Non-reversible			Reversible for external pilot air supply		
Exhaust function	With flow control					
Manual override	Pushing (non-detenting)					
Type of mounting	On individual/manifold sub-base					
Mounting position	Any					
Nominal size	[mm]	9				
Flow rate of valve	[l/min]	1,250		1,400	1,400	
Flow rate of valve on individual sub-base	[l/min]	1,100		1,200	1,200	
Flow rate of valve on manifold sub-base	[l/min]	900		1,100	1,000	
Standard nominal flow rate	[l/min]	900		1,100	1,000	
Switching time on/off, pneumatic spring	[ms]	20/28		35/43	–	–
Switching time on/off, mechanical spring	[ms]	–		26/56	–	23/58
Switching time on/off, for N, F and W	[ms]	28/20		–	–	–
Changeover time	[ms]	–		–	18	–
Freedom from overlap	Yes					
Width	[mm]	26				
Ports on the sub-base	1, 2, 3, 4, 5	G ¹ / ₄				
	12, 14	M5				
Tightening torque, valve mounting	[Nm]	1.62 ... 2.18				
Product weight	[g]	305		260	305	
Noise level	[dB (A)]	85				
Conforms to	ISO 15407-1 and interface for valve actuator ISO 15218					
Corrosion resistance class	CRC	2 ⁸⁾				

1) C=Normally closed

2) U=Normally open

3) E=Normally exhausted

4) H=2x 3/2-way valve in one housing with 1x normally closed and 1x normally open

5) N=Normally closed, reverse operation, i.e. the pressure supply ports are 3 and 5, venting is via port 1

6) F=Normally open, reverse operation, i.e. the pressure supply ports are 3 and 5, venting is via port 1

7) W=2x 3/2-way valve in one housing with 1x normally closed and 1x normally open,

reverse operation, i.e. the pressure supply ports are 3 and 5, venting is via port 1

8) Corrosion resistance class 2 to Festo standard 940 070

Components subject to moderate corrosion stress. Externally visible parts with primarily decorative surface requirements which are in direct contact with a normal industrial environment or media such as coolants or lubricating agents

Solenoid valves VSVA, ISO 15407-1/plug type C

Technical data – Directional control valves width 26 mm

Operating and environmental conditions			2x 3/2	5/2	5/3
Valve function			2x 3/2	5/2	5/3
Operating medium			Filtered compressed air, grade of filtration 40µm, lubricated or unlubricated, vacuum		
Operating pressure	Internal pilot air supply	[bar]	2 ... 10		3 ... 10
	External pilot air supply	[bar]	2... 10	-0.9 ... 16	
Pilot pressure with pneumatic spring		[bar]	2 ... 10 ¹⁾	2 ... 10	-
Pilot pressure with mechanical spring		[bar]	-	3 ... 10	3 ... 10
Ambient temperature		[°C]	-5 ... +50		
Temperature of medium		[°C]	-5 ... +50		
Fire protection classification to UL94			HB		

1) Pilot pressure dependent on operating pressure → Graph

Minimum pilot pressure p12, p14 as a function of the operating pressure p1 (external pilot air supply)

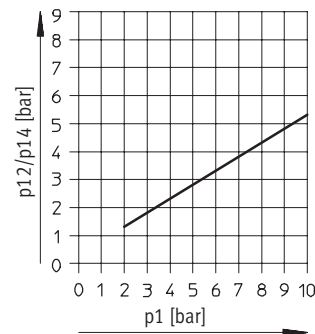

Electrical data		
Electrical connection		
Plug, square design to DIN EN 175301-803, type C		
		12 V/24 V DC/AC without protective earth conductor
		110 V/230 V AC with protective earth conductor
Operating voltage	DC voltage	[V DC]
	AC voltage	[V AC]
DC voltage		[W]
AC voltage		[VA]
Duty cycle		[%]
Protection class to EN 60529		
CE mark		

Solenoid valves VSVA, ISO 15407-1/plug type C

Technical data – Directional control valves 26



Materials

Sectional view

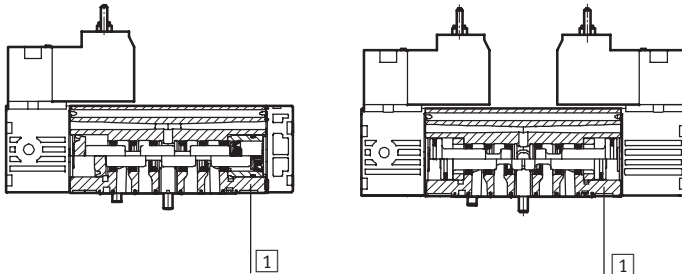

1	Housing	Die-cast aluminium
-	Seals	Nitrile rubber
-	Screws	Galvanised steel
-	Note on materials	Contains paint wetting impairment substances

Dimensions

Download CAD data → www.festo.com/en/engineering

5/2-way valve, single solenoid

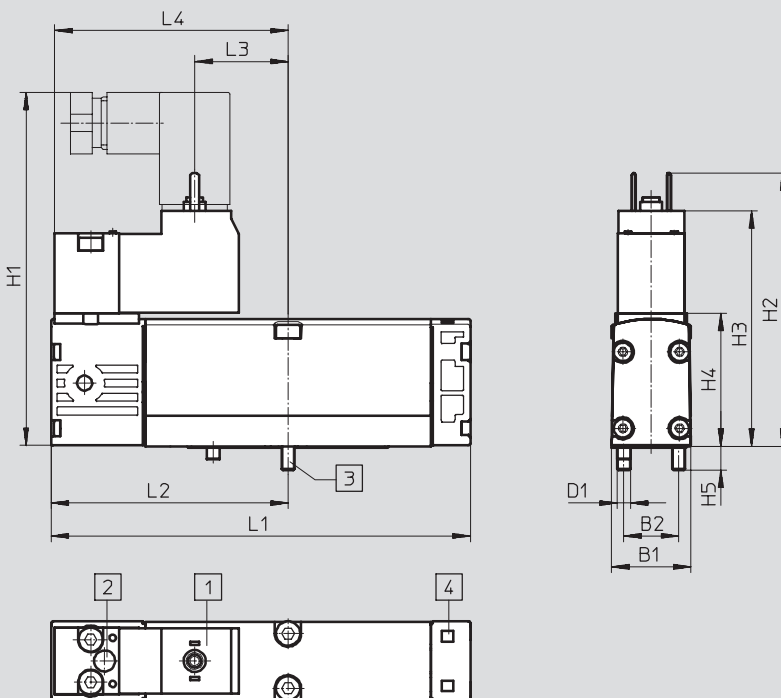

- 1 Connection dimensions and device plug to DIN EN 175301-803, type C
- 2 Manual override
- 3 Captive screws
- 4 Slot for inscription label

	B1	B2	D1	H1	H2	H3	H4	H5	L1	L2	L3	L4	L5
VSVA-B-M52...	26.3	19	M4	89.2	71.2	62.6	39.3	7	113.1	63.1	29.75	61.6	123.2

Solenoid valves VSVA, ISO 15407-1/plug type C

Technical data – Directional control valves 26

Dimensions

Download CAD data → www.festo.com/en/engineering

2x 3/2-way valve, 5/2-way valve, double solenoid, 5/3-way valve

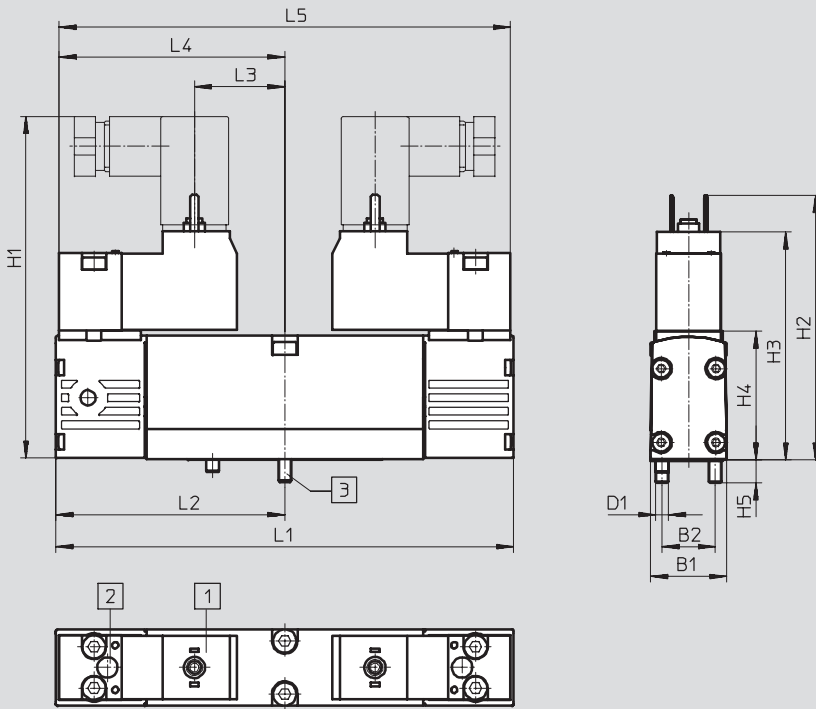

- 1 Connection dimensions and device plug to DIN EN 175301-803, type C
- 2 Manual override
- 3 Captive screws
- 4 Slot for inscription label

	B1	B2	D1	H1	H2	H3	H4	H5	L1	L2	L3	L4	L5
VSVA-B-M52...	26.3	19	M4	89.2	71.2	62.2	39.3	7	126.2	63.1	29.75	61.6	123.2

Dimensions

Download CAD data → www.festo.com/en/engineering

5/2-way valve, single solenoid – Valve actuator for widths 18 mm and 26 mm

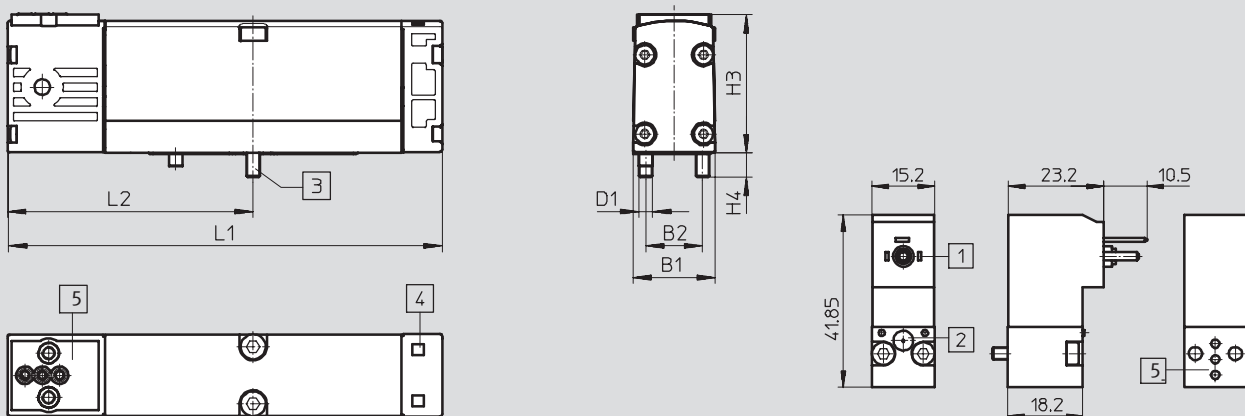

- 1 Connection dimensions and device plug to DIN EN 175301-803, type C
- 2 Manual override
- 3 Captive screws
- 4 Slot for inscription label
- 5 Pneumatic port pattern to ISO 15218

	B1	B2	D1	H4	H5	L1	L2
VSVA-B-M52...	26.3	19	M4	39.3	7	113.1	63.1

Solenoid valves VSVA, ISO 15407-1/plug type C

Technical data – Directional control valves width 26 mm

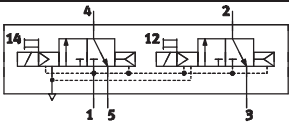
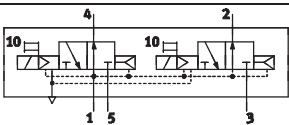
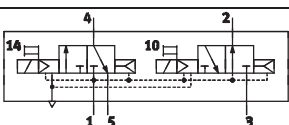
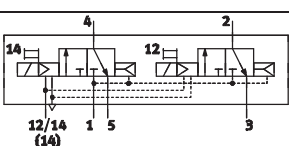
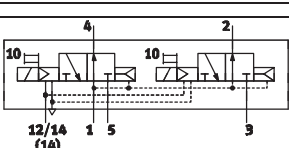
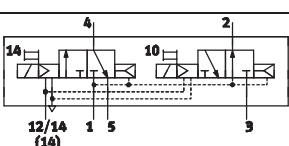
Ordering data – 2x 3/2-way valve ¹⁾						
Code	Circuit symbol	Normal position	Pilot air supply	Voltage		Part No. Type
				V DC	V AC	
K		2x closed	Internal	24	–	546 692 VSVA-B-T32C-AH-A1-1C1
				12	–	547 128 VSVA-B-T32C-AH-A1-5C1
				–	230	547 208 VSVA-B-T32C-AH-A1-3AC1
				–	110	547 168 VSVA-B-T32C-AH-A1-2AC1
				–	24	547 088 VSVA-B-T32C-AH-A1-1AC1
N		2x open	Internal	24	–	546 694 VSVA-B-T32U-AH-A1-1C1
				12	–	547 130 VSVA-B-T32U-AH-A1-5C1
				–	230	547 210 VSVA-B-T32U-AH-A1-3AC1
				–	110	547 170 VSVA-B-T32U-AH-A1-2AC1
				–	24	547 090 VSVA-B-T32U-AH-A1-1AC1
H		1x closed 1x open	Internal	24	–	547 066 VSVA-B-T32H-AH-A1-1C1
				12	–	547 132 VSVA-B-T32H-AH-A1-5C1
				–	230	547 212 VSVA-B-T32H-AH-A1-3AC1
				–	110	547 172 VSVA-B-T32H-AH-A1-2AC1
				–	24	547 092 VSVA-B-T32H-AH-A1-1AC1
K		2x closed	External	24	–	547 068 VSVA-B-T32C-AZH-A1-1C1
				12	–	547 148 VSVA-B-T32C-AZH-A1-5C1
				–	230	547 228 VSVA-B-T32C-AZH-A1-3AC1
				–	110	547 188 VSVA-B-T32C-AZH-A1-2AC1
				–	24	547 108 VSVA-B-T32C-AZH-A1-1AC1
N		2x open	External	24	–	547 070 VSVA-B-T32U-AZH-A1-1C1
				12	–	547 150 VSVA-B-T32U-AZH-A1-5C1
				–	230	547 230 VSVA-B-T32U-AZH-A1-3AC1
				–	110	547 190 VSVA-B-T32U-AZH-A1-2AC1
				–	24	547 110 VSVA-B-T32U-AZH-A1-1AC1
H		1x closed 1x open	External	24	–	547 072 VSVA-B-T32H-AZH-A1-1C1
				12	–	547 152 VSVA-B-T32H-AZH-A1-5C1
				–	230	547 232 VSVA-B-T32H-AZH-A1-3AC1
				–	110	547 192 VSVA-B-T32H-AZH-A1-2AC1
				–	24	547 112 VSVA-B-T32H-AZH-A1-1AC1

1) 2x 3/2-way valves for reverse operation on request

Solenoid valves VSVA, ISO 15407-1/plug type C

Technical data – Directional control valves width 26 mm

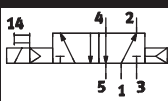
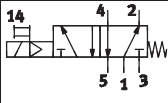
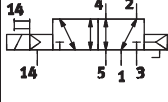
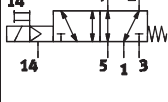
Ordering data – 5/2-way valve, single solenoid (monostable)							
Code	Circuit symbol	Reset method	Pilot air supply	Voltage		Part No.	Type
				V DC	V AC		
M		Pneumatic	Internal	24	–	546 700	VSVA-B-M52-AH-A1-1C1
				12	–	547 138	VSVA-B-M52-AH-A1-5C1
				–	230	547 218	VSVA-B-M52-AH-A1-3AC1
				–	110	547 178	VSVA-B-M52-AH-A1-2AC1
				–	24	547 098	VSVA-B-M52-AH-A1-1AC1
O		Mechanical spring	Internal	24	–	546 702	VSVA-B-M52-MH-A1-1C1
				12	–	547 140	VSVA-B-M52-MH-A1-5C1
				–	230	547 220	VSVA-B-M52-MH-A1-3AC1
				–	110	547 180	VSVA-B-M52-MH-A1-2AC1
				–	24	547 100	VSVA-B-M52-MH-A1-1AC1
M		Pneumatic	External	24	–	547 078	VSVA-B-M52-AZH-A1-1C1
				12	–	547 158	VSVA-B-M52-AZH-A1-5C1
				–	230	547 238	VSVA-B-M52-AZH-A1-3AC1
				–	110	547 198	VSVA-B-M52-AZH-A1-2AC1
				–	24	547 118	VSVA-B-M52-AZH-A1-1AC1
O		Mechanical spring	External	24	–	547 080	VSVA-B-M52-MZH-A1-1C1
				12	–	547 160	VSVA-B-M52-MZH-A1-5C1
				–	230	547 240	VSVA-B-M52-MZH-A1-3AC1
				–	110	547 200	VSVA-B-M52-MZH-A1-2AC1
				–	24	547 120	VSVA-B-M52-MZH-A1-1AC1

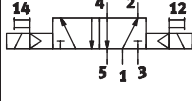
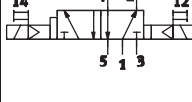
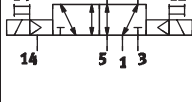
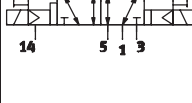
Ordering data – 5/2-way valve, double solenoid (bistable)							
Code	Circuit symbol	Dominance	Pilot air supply	Voltage		Part No.	Type
				V DC	V AC		
J		1st signal	Internal	24	–	546 696	VSVA-B-B52-H-A1-1C1
				12	–	547 134	VSVA-B-B52-H-A1-5C1
				–	230	547 214	VSVA-B-B52-H-A1-3AC1
				–	110	547 174	VSVA-B-B52-H-A1-2AC1
				–	24	547 094	VSVA-B-B52-H-A1-1AC1
D		At 14	Internal	24	–	546 698	VSVA-B-D52-H-A1-1C1
				12	–	547 136	VSVA-B-D52-H-A1-5C1
				–	230	547 216	VSVA-B-D52-H-A1-3AC1
				–	110	547 176	VSVA-B-D52-H-A1-2AC1
				–	24	547 096	VSVA-B-D52-H-A1-1AC1
J		1st signal	External	24	–	547 074	VSVA-B-B52-ZH-A1-1C1
				12	–	547 154	VSVA-B-B52-ZH-A1-5C1
				–	230	547 234	VSVA-B-B52-ZH-A1-3AC1
				–	110	547 194	VSVA-B-B52-ZH-A1-2AC1
				–	24	547 114	VSVA-B-B52-ZH-A1-1AC1
D		At 14	External	24	–	547 076	VSVA-B-D52-ZH-A1-1C1
				12	–	547 156	VSVA-B-D52-ZH-A1-5C1
				–	230	547 236	VSVA-B-D52-ZH-A1-3AC1
				–	110	547 196	VSVA-B-D52-ZH-A1-2AC1
				–	24	547 116	VSVA-B-D52-ZH-A1-1AC1

Solenoid valves VSVA, ISO 15407-1/plug type C

Technical data – Directional control valves width 26 mm

FESTO

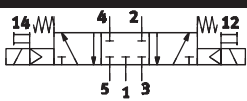
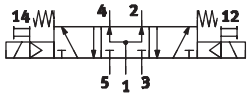
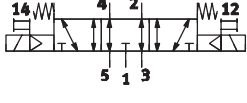
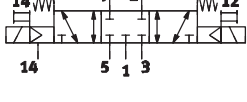
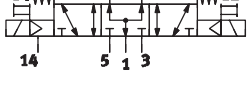
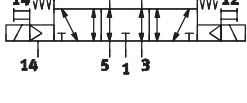
Ordering data – 5/3-way valve, double solenoid (monostable)							
Code	Circuit symbol	Normal position	Pilot air supply	Voltage		Part No.	Type
				V DC	V AC		
G		Closed	Internal	24	–	546 708	VSVA-B-P53C-H-A1-1C1
				12	–	547 146	VSVA-B-P53C-H-A1-5C1
				–	230	547 226	VSVA-B-P53C-H-A1-3AC1
				–	110	547 186	VSVA-B-P53C-H-A1-2AC1
				–	24	547 106	VSVA-B-P53C-H-A1-1AC1
B		Open	Internal	24	–	546 704	VSVA-B-P53U-H-A1-1C1
				12	–	547 142	VSVA-B-P53U-H-A1-5C1
				–	230	547 222	VSVA-B-P53U-H-A1-3AC1
				–	110	547 182	VSVA-B-P53U-H-A1-2AC1
				–	24	547 102	VSVA-B-P53U-H-A1-1AC1
E		Exhausted	Internal	24	–	546 706	VSVA-B-P53E-H-A1-1C1
				12	–	547 144	VSVA-B-P53E-H-A1-5C1
				–	230	547 224	VSVA-B-P53E-H-A1-3AC1
				–	110	547 184	VSVA-B-P53E-H-A1-2AC1
				–	24	547 104	VSVA-B-P53E-H-A1-1AC1
G		Closed	External	24	–	547 086	VSVA-B-P53C-ZH-A1-1C1
				12	–	547 166	VSVA-B-P53C-ZH-A1-5C1
				–	230	547 246	VSVA-B-P53C-ZH-A1-3AC1
				–	110	547 206	VSVA-B-P53C-ZH-A1-2AC1
				–	24	547 126	VSVA-B-P53C-ZH-A1-1AC1
B		Open	External	24	–	547 082	VSVA-B-P53U-ZH-A1-1C1
				12	–	547 162	VSVA-B-P53U-ZH-A1-5C1
				–	230	547 242	VSVA-B-P53U-ZH-A1-3AC1
				–	110	547 202	VSVA-B-P53U-ZH-A1-2AC1
				–	24	547 122	VSVA-B-P53U-ZH-A1-1AC1
E		Exhausted	External	24	–	547 084	VSVA-B-P53E-ZH-A1-1C1
				12	–	547 164	VSVA-B-P53E-ZH-A1-5C1
				–	230	547 244	VSVA-B-P53E-ZH-A1-3AC1
				–	110	547 204	VSVA-B-P53E-ZH-A1-2AC1
				–	24	547 124	VSVA-B-P53E-ZH-A1-1AC1

Solenoid valves VSVA, ISO 15407-1/plug type C



Technical data – Directional control valves width 26 mm without valve actuators

Ordering data – 2x 3/2-way valve without valve actuator				
Design	Normal position	Pilot air supply	Part No.	Type
	2x closed	Internal	546 731	VSVA-B-T32C-A-A1-P1
	2x open	Internal	546 733	VSVA-B-T32U-A-A1-P1

Ordering data – 5/2-way valve, single solenoid (monostable) without valve actuator				
Design	Reset method	Pilot air supply	Part No.	Type
	Pneumatic	Internal	546 739	VSVA-B-M52-A-A1-P1
	Mechanical spring	Internal	546 741	VSVA-B-M52-M-A1-P1

Ordering data – 5/2-way double solenoid (bistable) valve without valve actuator				
Design	Dominance	Pilot air supply	Part No.	Type
	1st signal	Internal	546 735	VSVA-B-B52-A1-P1
	At 14	Internal	546 737	VSVA-B-D52-A1-P1

Ordering data – 5/3-way mid-position valve (monostable) without valve actuator				
Design	Normal position	Pilot air supply	Part No.	Type
	Closed	Internal	546 747	VSVA-B-P53C-A1-P1
	Open	Internal	546 743	VSVA-B-P53U-A1-P1
	Exhausted	Internal	546 745	VSVA-B-P53E-A1-P1

Ordering data – Valve actuator to ISO 15218								
Design	Plug, square design	Protective earth conductor	Output		Voltage		Part No.	Type
			[W]	[VA]	V DC	V AC		
	DIN EN 175301-803, type C	No	1.8	–	24	–	546 256	VSCS-B-M32-MH-WA-1C1
		No	1.8	–	12	–	546 257	VSCS-B-M32-MH-WA-5C1
	DIN EN 175301-803, type C	Yes	–	2.1	–	230	546 260	VSCS-B-M32-MH-WA-3AC1
		Yes	–	2.1	–	110	546 259	VSCS-B-M32-MH-WA-2AC1
		No	–	2.3	–	24	546 258	VSCS-B-M32-MH-WA-1AC1

Solenoid valves VSVA, ISO 15407-1/central plug M8x1

Technical data – Directional control valves width 18 mm



 Flow rate
650 l/min

 Voltage
24 V DC



General technical data							
Valve function	2x 3/2			5/2		5/3	
Normal position	C ¹⁾	U ²⁾	H ⁴⁾	–	–	C ¹⁾	U ²⁾ E ³⁾
Memory stability	Monostable				Bistable		Monostable
Pneumatic spring reset method	Yes			Yes	–	No	
Mechanical spring reset method	No			Yes	–	Yes	
Design	Piston spool valve						
Sealing principle	Soft						
Actuation type	Electrical						
Control type	Piloted						
Pilot air supply	Internal or external						
Direction of flow	Non-reversible			Reversible for external pilot air supply			
Exhaust function	With flow control						
Manual override	Pushing (non-detenting)						
Type of mounting	On individual/manifold sub-base						
Mounting position	Any						
Nominal size	[mm]	5					
Flow rate of valve	[l/min]	550	700		650		
Standard nominal flow rate	[l/min]	400	550		450		
Switching time on/off, pneumatic spring	[ms]	10/22		20/25	–	–	
Switching time on/off, mechanical spring	[ms]	–		12/34	–	15/36	
Changeover time	[ms]	–			10	–	
Freedom from overlap	Yes						
Width	[mm]	18					
Ports on the sub-base	1, 2, 3, 4, 5	G1/8					
	12, 14	M5					
Tightening torque, valve mounting	[Nm]	0.68 ... 0.92					
Product weight	[g]	140	140	140	140		
Noise level	[dB (A)]	85					
Conforms to	ISO 15407-1 and interface for valve actuator ISO 15218						
Corrosion resistance class	CRC	2 ⁵⁾					

1) C=Normally closed

2) U=Normally open

3) E=Normally exhausted

4) H=2x 3/2-way valve in one housing with 1x normally closed and 1x normally open

5) Corrosion resistance class 2 to Festo standard 940 070

Components subject to moderate corrosion stress. Externally visible parts with primarily decorative surface requirements which are in direct contact with a normal industrial environment or media such as coolants or lubricating agents

Solenoid valves VSVA, ISO 15407-1/central plug M8x1

Technical data – Directional control valves width 18 mm

Operating and environmental conditions				
Valve function		2x 3/2	5/2	5/3
Operating medium		Filtered compressed air, grade of filtration 40µm, lubricated or unlubricated, vacuum		
Operating pressure	Internal pilot air supply [bar]	3 ... 8		3 ... 8
	External pilot air supply [bar]	3 ... 10	-0.9 ... 10	
Pilot pressure [bar]		3 ... 8 ¹⁾	3 ... 8	3 ... 8
Ambient temperature [°C]		-5 ... +50		
Temperature of medium [°C]		-5 ... +50		
Fire protection classification to UL94		V0		

1) Pilot pressure dependent on operating pressure → Graph

Minimum pilot pressure p12, p14 as a function of the operating pressure p1 (external pilot air supply)

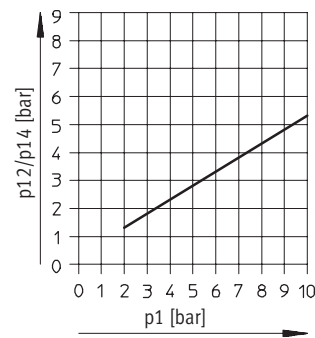

Electrical data			
Electrical connection to IEC 60 947-5-2		Central plug, round design, M8x1	
Coil characteristics	Voltage [V DC]	21.6 ... 26.4	
	Output [W]	High-current phase: 2.4; low-current phase: 1 ¹⁾	
Duty cycle	%	100	
Protection class to EN 60529		IP65 (in combination with plug socket)	
Protective circuit and LED		Integrated in the valve	
CE mark		89/336/EEC (EMC)	

1) Controlled by integrated current reduction

Solenoid valves VSVA, ISO 15407-1/central plug M8x1

FESTO

Technical data – Directional control valves width 18 mm

Materials

Sectional view

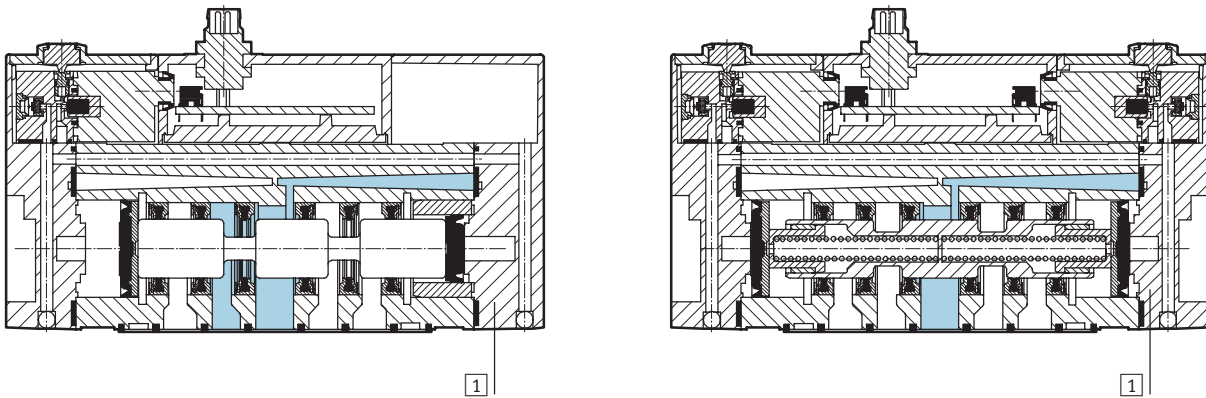

1	Housing	Die-cast aluminium, polyacetate
-	Seals	Nitrile rubber

Dimensions

Download CAD data → www.festo.com/en/engineering

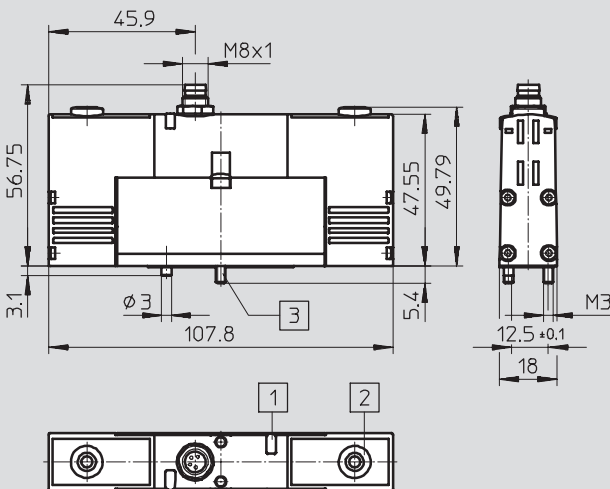

- 1 Light emitting diode (LED)
- 2 Manual override
- 3 Captive mounting screws

M8x1 – Terminal allocation

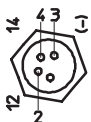



- 1 Unused
- 2 Signal (+) Solenoid 12/10
- 3 com (-)
- 4 Signal (+) Solenoid 14/10

Solenoid valves VSVA, ISO 15407-1/central plug M8x1

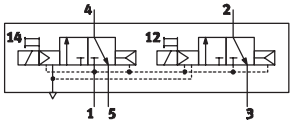
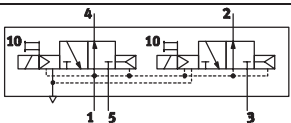
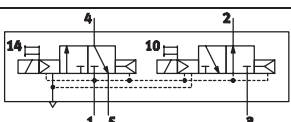
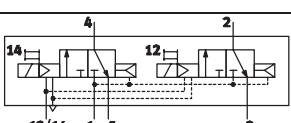
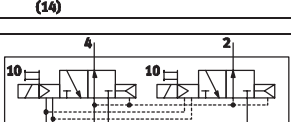
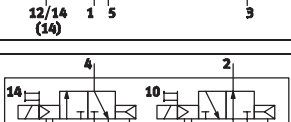

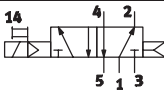
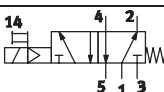
Technical data – Directional control valves width 18 mm

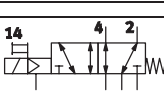
Ordering data – 2x 3/2-way valve						
Code	Circuit symbol	Normal position	Pilot air supply	Plug M8x1	Part No.	Type
K		2x closed	Internal	24 V DC	534 771	VSVA-B-T32C-AH-A2-1R2L
N		2x open	Internal	24 V DC	534 772	VSVA-B-T32U-AH-A2-1R2L
H		1x closed 1x open	Internal	24 V DC	534 773	VSVA-B-T32H-AH-A2-1R2L
K		2x closed	External	24 V DC	534 781	VSVA-B-T32C-AZH-A2-1R2L
N		2x open	External	24 V DC	534 782	VSVA-B-T32U-AZH-A2-1R2L
H		1x closed 1x open	External	24 V DC	534 783	VSVA-B-T32H-AZH-A2-1R2L

Ordering data – 5/2-way valve, single solenoid (monostable)						
Code	Circuit symbol	Reset method	Pilot air supply	Plug M8x1	Part No.	Type
M		Pneumatic	Internal	24 V DC	534 774	VSVA-B-M52-AH-A2-1R2L
O		Mechanical spring	Internal	24 V DC	534 775	VSVA-B-M52-MH-A2-1R2L
M		Pneumatic	External	24 V DC	534 784	VSVA-B-M52-AZH-A2-1R2L
O		Mechanical spring	External	24 V DC	534 785	VSVA-B-M52-MZH-A2-1R2L

Solenoid valves VSVA, ISO 15407-1/central plug M8x1

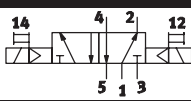
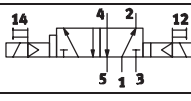
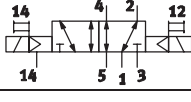
Technical data – Directional control valves 18

Ordering data – 5/2-way valve, double solenoid (bistable)						
Code	Circuit symbol	Dominance	Pilot air supply	Plug M8x1	Part No.	Type
J		1st signal	Internal	24 V DC	534 776	VSVA-B-B52-H-A2-1R2L
D		At 14	Internal	24 V DC	534 777	VSVA-B-D52-H-A2-1R2L
J		1st signal	External	24 V DC	534 786	VSVA-B-B52-ZH-A2-1R2L
D		At 14	External	24 V DC	534 787	VSVA-B-D52-ZH-A2-1R2L

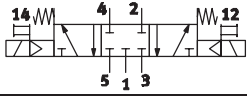
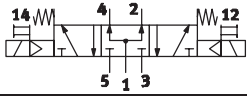
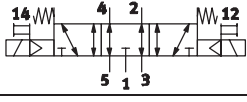
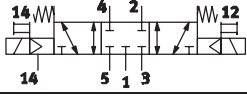
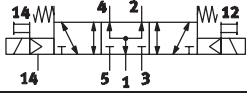
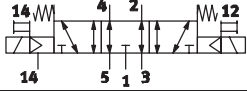
Ordering data – 5/3-way valve, double solenoid (monostable)						
Code	Circuit symbol	Normal position	Pilot air supply	Plug M8x1	Part No.	Type
G		Closed	Internal	24 V DC	534 778	VSVA-B-P53C-H-A2-1R2L
B		Open	Internal	24 V DC	534 780	VSVA-B-P53U-H-A2-1R2L
E		Exhausted	Internal	24 V DC	534 779	VSVA-B-P53E-H-A2-1R2L
G		Closed	External	24 V DC	534 788	VSVA-B-P53C-ZH-A2-1R2L
B		Open	External	24 V DC	534 790	VSVA-B-P53U-ZH-A2-1R2L
E		Exhausted	External	24 V DC	534 789	VSVA-B-P53E-ZH-A2-1R2L

Solenoid valves VSVA, ISO 15407-1/central plug M8x1, M12x1

Technical data – Directional control valves width 26 mm

-  - Flow rate
1,250 ... 1,400 l/min

-  - Voltage
24 V DC



General technical data								
Valve function	2x 3/2			5/2		5/3		
Normal position	C ¹⁾	U ²⁾	H ⁴⁾	–	–	C ¹⁾	U ²⁾	E ³⁾
Memory stability	Monostable				Bistable		Monostable	
Pneumatic spring reset method	Yes			Yes	–	No		
Mechanical spring reset method	No			Yes	–	Yes		
Design	Piston spool valve							
Sealing principle	Soft							
Actuation type	Electrical							
Control type	Piloted							
Pilot air supply	Internal or external							
Direction of flow	Non-reversible			Reversible for external pilot air supply				
Exhaust function	With flow control							
Manual override	Pushing (non-detenting)							
Type of mounting	On sub-base/manifold							
Mounting position	Any							
Nominal size	[mm]	9						
Flow rate of valve	[l/min]	11,250		1,400		1,400		
Standard nominal flow rate	[l/min]	900		1,100		1,000		
Switching time on/off, pneumatic spring	[ms]	20/33		25/40		–		–
Switching time on/off, mechanical spring	[ms]	–		20/52		–		20/52
Changeover time, dominance at 1st signal	[ms]	–			15		–	
Changeover time, dominance at 14	[ms]	–			25		–	
Freedom from overlap	Yes							
Width	[mm]	26						
Ports on the sub-base	1, 2, 3, 4, 5	G1/4						
	12, 14	M5						
Tightening torque, valve mounting	[Nm]	1.62 ... 2.18						
Product weight	[g]	270		270		270		
Noise level	[dB (A)]	85						
Conforms to	ISO 15407-1							
Corrosion resistance class	CRC	2 ⁵⁾						

- 1) C=Normally closed
- 2) U=Normally open
- 3) E=Normally exhausted
- 4) H=2x 3/2-way valve in one housing with 1x normally closed and 1x normally open
- 5) Corrosion resistance class 2 to Festo standard 940 070
Components subject to moderate corrosion stress. Externally visible parts with primarily decorative surface requirements which are in direct contact with a normal industrial environment or media such as coolants or lubricating agents

Solenoid valves VSVA, ISO 15407-1/central plug M8x1, M12x1

Technical data – Directional control valves width 26 mm

Operating and environmental conditions				
Valve function		2x 3/2	5/2	5/3
Operating medium		Filtered compressed air, grade of filtration 40µm, lubricated or unlubricated, vacuum		
Operating pressure	Internal pilot air supply [bar]	3 ... 8		3 ... 8
	External pilot air supply [bar]	3 ... 10	-0.9 ... 16	
Pilot pressure	[bar]	3 ... 8 ¹⁾	3 ... 8	3 ... 8
Ambient temperature	[°C]	-5 ... +50		
Temperature of medium	[°C]	-5 ... +50		
Fire protection classification to UL94		V0		

1) Pilot pressure dependent on operating pressure → Graph

Minimum pilot pressure p12, p14 as a function of the operating pressure p1 (external pilot air supply)

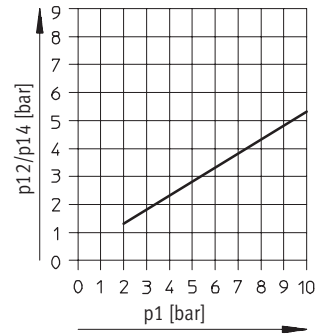

Electrical data			
Electrical connection to IEC 60 947-5-2		Central plug, round design, M8x1 or M12x1	
Coil characteristics	Voltage	[V DC]	21.6 ... 26.4
	Output	[W]	High-current phase: 2.4; low-current phase: 1 ¹⁾
Duty cycle		%	100
Protection class to EN 60529		IP65 (in combination with plug socket)	
Protective circuit and LED		Integrated in the valve	
CE mark		89/336/EEC (EMC)	

1) Controlled by integrated current reduction

Solenoid valves VSVA, ISO 15407-1/central plug M8x1, M12x1

Technical data – Directional control valves width 26 mm

Materials

Sectional view

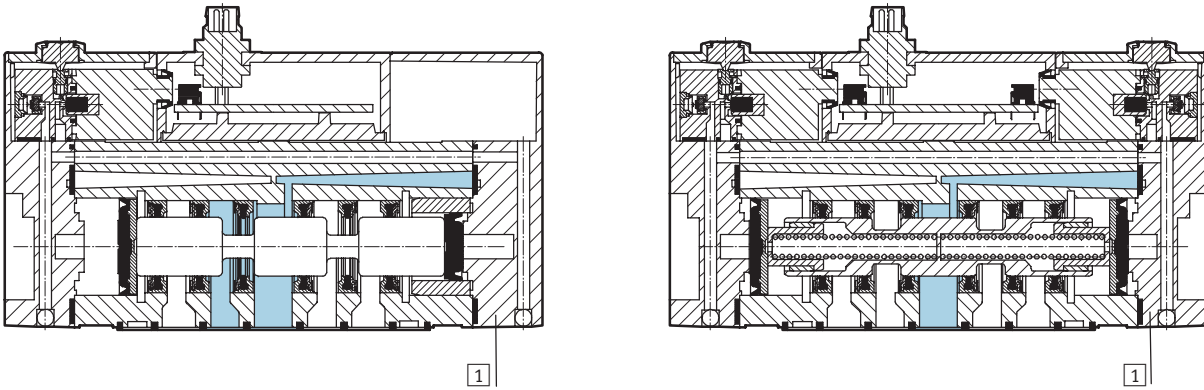

1	Housing	Die-cast aluminium, polyacetate
-	Seals	Nitrile rubber

Dimensions

Download CAD data → www.festo.com/en/engineering

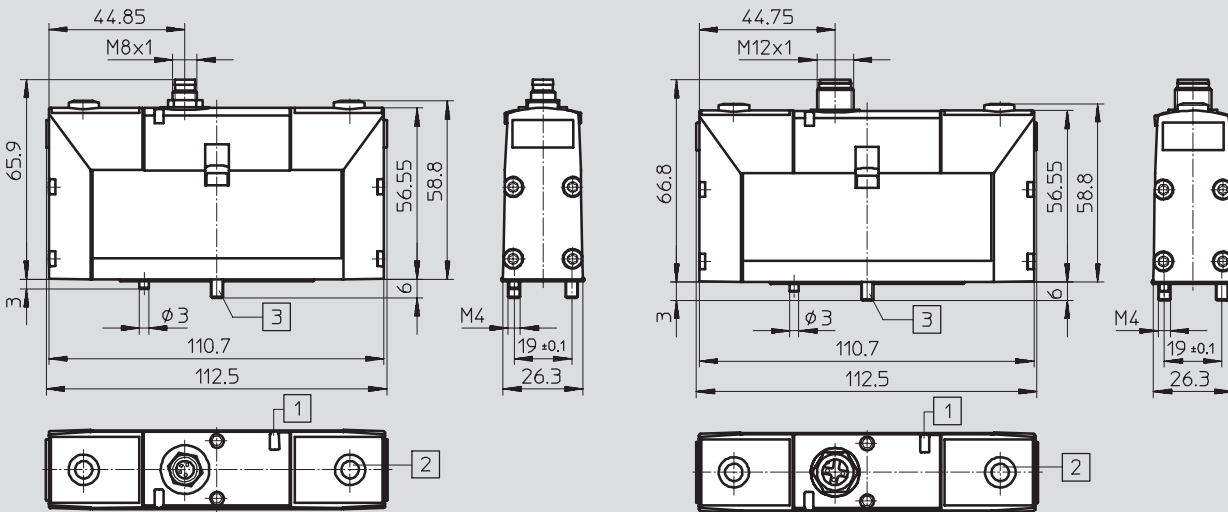

- 1 Light emitting diode (LED)
- 2 Manual override
- 3 Captive mounting screws

M8x1 – Terminal allocation

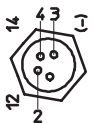

- 1 Unused
- 2 Signal (+) Solenoid 12/10
- 3 com (-)
- 4 Signal (+) Solenoid 14/10

M12x1 – Terminal allocation

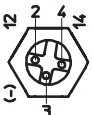

- 2 Signal (+) Solenoid 12
- 3 com (-)
- 4 Signal (+) Solenoid 14

Solenoid valves VSVA, ISO 15407-1/central plug M8x1, M12x1

Technical data – Directional control valves width 26 mm

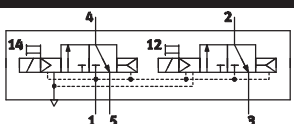
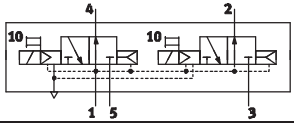
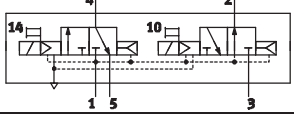
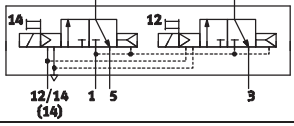
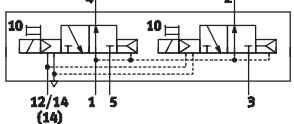
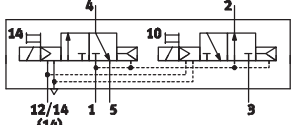

FESTO

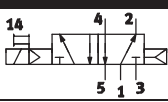
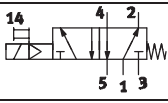
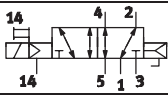
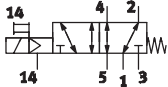
Ordering data – 2x 3/2-way valve						
Code	Circuit symbol	Normal position	Pilot air supply	Plug		Part No. Type
				M8x1	M12x1	
K		2x closed	Internal	24 V DC	–	534 532 VSVA-B-T32C-AH-A1-1R2L
				–	24 V DC	534 552 VSVA-B-T32C-AH-A1-1R5L
N		2x open	Internal	24 V DC	–	534 533 VSVA-B-T32U-AH-A1-1R2L
				–	24 V DC	534 553 VSVA-B-T32U-AH-A1-1R5L
H		1x closed 1x open	Internal	24 V DC	–	534 534 VSVA-B-T32H-AH-A1-1R2L
				–	24 V DC	534 554 VSVA-B-T32H-AH-A1-1R5L
K		2x closed	External	24 V DC	–	534 522 VSVA-B-T32C-AZH-A1-1R2L
				–	24 V DC	534 542 VSVA-B-T32C-AZH-A1-1R5L
N		2x open	External	24 V DC	–	534 523 VSVA-B-T32U-AZH-A1-1R2L
				–	24 V DC	534 543 VSVA-B-T32U-AZH-A1-1R5L
H		1x closed 1x open	External	24 V DC	–	534 524 VSVA-B-T32H-AZH-A1-1R2L
				–	24 V DC	534 544 VSVA-B-T32H-AZH-A1-1R5L

Ordering data – 5/2-way valve, single solenoid (monostable)						
Code	Circuit symbol	Reset method	Pilot air supply	Plug		Part No. Type
				M8x1	M12x1	
M		Pneumatic	Internal	24 V DC	–	534 535 VSVA-B-M52-AH-A1-1R2L
				–	24 V DC	534 555 VSVA-B-M52-AH-A1-1R5L
O		Mechanical spring	Internal	24 V DC	–	534 536 VSVA-B-M52-MH-A1-1R2L
				–	24 V DC	534 556 VSVA-B-M52-MH-A1-1R5L
M		Pneumatic	External	24 V DC	–	534 525 VSVA-B-M52-AZH-A1-1R2L
				–	24 V DC	534 545 VSVA-B-M52-AZH-A1-1R5L
O		Mechanical spring	External	24 V DC	–	534 526 VSVA-B-M52-MZH-A1-1R2L
				–	24 V DC	534 546 VSVA-B-M52-MZH-A1-1R5L

Solenoid valves VSVA, ISO 15407-1/central plug M8x1, M12x1

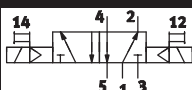
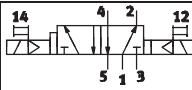
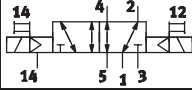
Technical data – Directional control valves width 26 mm

Ordering data – 5/2-way valve, double solenoid (bistable)							
Code	Circuit symbol	Dominance	Pilot air supply	Plug		Part No.	Type
				M8x1	M12x1		
J		1st signal	Internal	24 V DC	–	534 537	VSVA-B-B52-H-A1-1R2L
				–	24 V DC	534 557	VSVA-B-B52-H-A1-1R5L
D		At 14	Internal	24 V DC	–	534 538	VSVA-B-D52-H-A1-1R2L
				–	24 V DC	534 558	VSVA-B-D52-H-A1-1R5L
J		1st signal	External	24 V DC	–	534 527	VSVA-B-B52-ZH-A1-1R2L
				–	24 V DC	534 547	VSVA-B-B52-ZH-A1-1R5L
D		At 14	External	24 V DC	–	534 528	VSVA-B-D52-ZH-A1-1R2L
				–	24 V DC	534 548	VSVA-B-D52-ZH-A1-1R5L

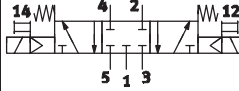
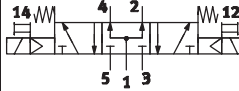
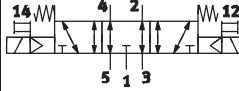
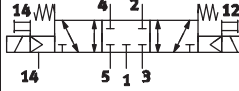
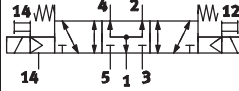
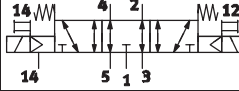
Ordering data – 5/3-way valve, double solenoid (monostable)							
Code	Circuit symbol	Normal position	Pilot air supply	Plug		Part No.	Type
				M8x1	M12x1		
G		Closed	Internal	24 V DC	–	534 539	VSVA-B-P53C-H-A1-1R2L
				–	24 V DC	534 559	VSVA-B-P53C-H-A1-1R5L
B		Open	Internal	24 V DC	–	534 541	VSVA-B-P53U-H-A1-1R2L
				–	24 V DC	534 561	VSVA-B-P53U-H-A1-1R5L
E		Exhausted	Internal	24 V DC	–	534 540	VSVA-B-P53E-H-A1-1R2L
				–	24 V DC	534 560	VSVA-B-P53E-H-A1-1R5L
G		Closed	External	24 V DC	–	534 529	VSVA-B-P53C-ZH-A1-1R2L
				–	24 V DC	534 549	VSVA-B-P53C-ZH-A1-1R5L
B		Open	External	24 V DC	–	534 531	VSVA-B-P53U-ZH-A1-1R2L
				–	24 V DC	534 551	VSVA-B-P53U-ZH-A1-1R5L
E		Exhausted	External	24 V DC	–	534 530	VSVA-B-P53E-ZH-A1-1R2L
				–	24 V DC	534 550	VSVA-B-P53E-ZH-A1-1R5L

Sub-bases, ISO 15407-1



Individual sub-base

Individual sub-base NAS

Materials:
Die-cast aluminium
Free of copper and PTFE

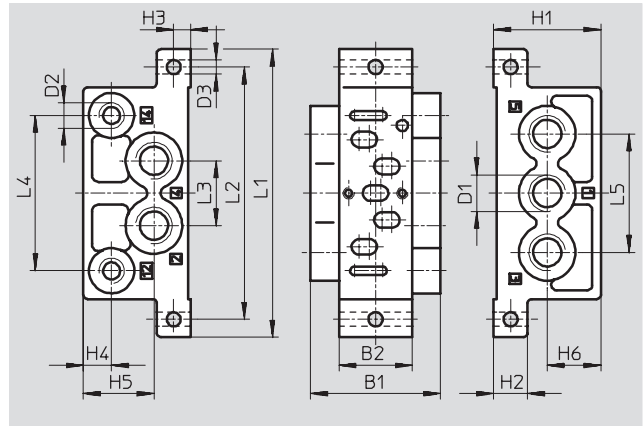
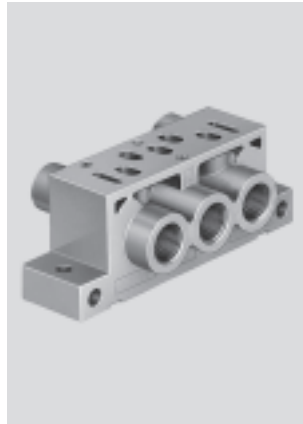

Dimensions and ordering data											
Width [mm]	B1	B2	D1	D2	D3 Ø	H1	H2	H3	H4	H5	H6
18	28.5	18	G $\frac{1}{8}$	M5	5.5	31	10	5	7	20	14.5
26	46	26	G $\frac{1}{4}$	G $\frac{1}{8}$	5	38	12	6	10	25	19

Dimensions and ordering data									
Width [mm]	L1	L2	L3	L4	L5	Weight [g]	Part No.	Type	
18	79	66.5	17	40	32	67	161 115	NAS- $\frac{1}{8}$ -02-VDMA	
26	102	89.4	23	55	42	160	161 109	NAS- $\frac{1}{4}$ -01-VDMA	

General technical data			
Width [mm]	18		26
Type of mounting	2 through-holes in housing		2 through-holes in housing
Pneumatic connection	1, 2, 3, 4, 5	G $\frac{1}{8}$	G $\frac{1}{4}$
	12, 14	M5	G $\frac{1}{8}$

Standard directional control valves
ISO 15407-1

1.3

Manifold components, ISO 15407-1

Horizontal stacking



Manifold sub-base NAW

Material:
Die-cast aluminium



Ordering data – NAW for solenoid valves					
Width [mm]	Pneumatic connection		Weight [g]	Part No.	Type
	1, 2, 3, 4, 5	12, 14			
18	G $\frac{1}{8}$	M5	130	161 110	NAW- $\frac{1}{8}$ -02-VDMA
26	G $\frac{1}{4}$	M5	225	161 102	NAW- $\frac{1}{4}$ -01-VDMA

Ordering data – NAW for pneumatic valves					
Width [mm]	Pneumatic connection		Weight [g]	Part No.	Type
	1, 2, 3, 4, 5	12, 14			
18	G $\frac{1}{8}$	M5	130	161 111	NAW- $\frac{1}{8}$ -02-VDMA-VL
26	G $\frac{1}{4}$	M5	225	161 103	NAW- $\frac{1}{4}$ -01-VDMA-VL

Dimensions → 2 / 1.1-68

Standard directional control valves
ISO 15407-1

1.3

End plate kit NEV

Material:
Die-cast aluminium

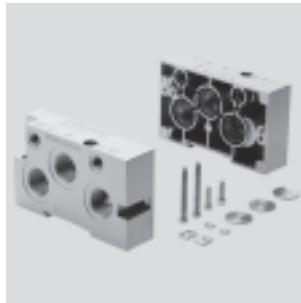

Ordering data					
Width [mm]	Pneumatic connection		Weight [g]	Part No.	Type
	1, 2, 3, 4, 5	12, 14			
18	G $\frac{3}{8}$	G $\frac{1}{8}$	280	161 112	NEV-02-VDMA
26	G $\frac{1}{2}$	G $\frac{1}{8}$	445	161 104	NEV-01-VDMA

Dimensions → 2 / 1.1-68

Manifold components, ISO 15407-1

Horizontal stacking



End plate kit NEV

Material:
Die-cast aluminium



Ordering data				
Width [mm]	Description	Weight [g]	Part No.	Type
18 and 26	One end plate of width 18 mm, one end plate of width 26 mm and fittings	372	191 405	NEV-02-01-VDMA

Dimensions → 2 / 1.1-68

Intermediate plate NZV

Material:
Die-cast aluminium
Free of copper and PTFE



Dimensions
Download CAD data → www.festo.com/en/engineering

Ordering data					
Width [mm]	Pneumatic connection		Weight [g]	Part No.	Type
	1, 2, 3, 4, 5	12, 14			
18 and 26	G1/2	-	270	161 108	NZV-01/02-VDMA

Manifold components, ISO 15407-1

Horizontal stacking



Dimensions – Manifold assembly

Download CAD data → www.festo.com/en/engineering

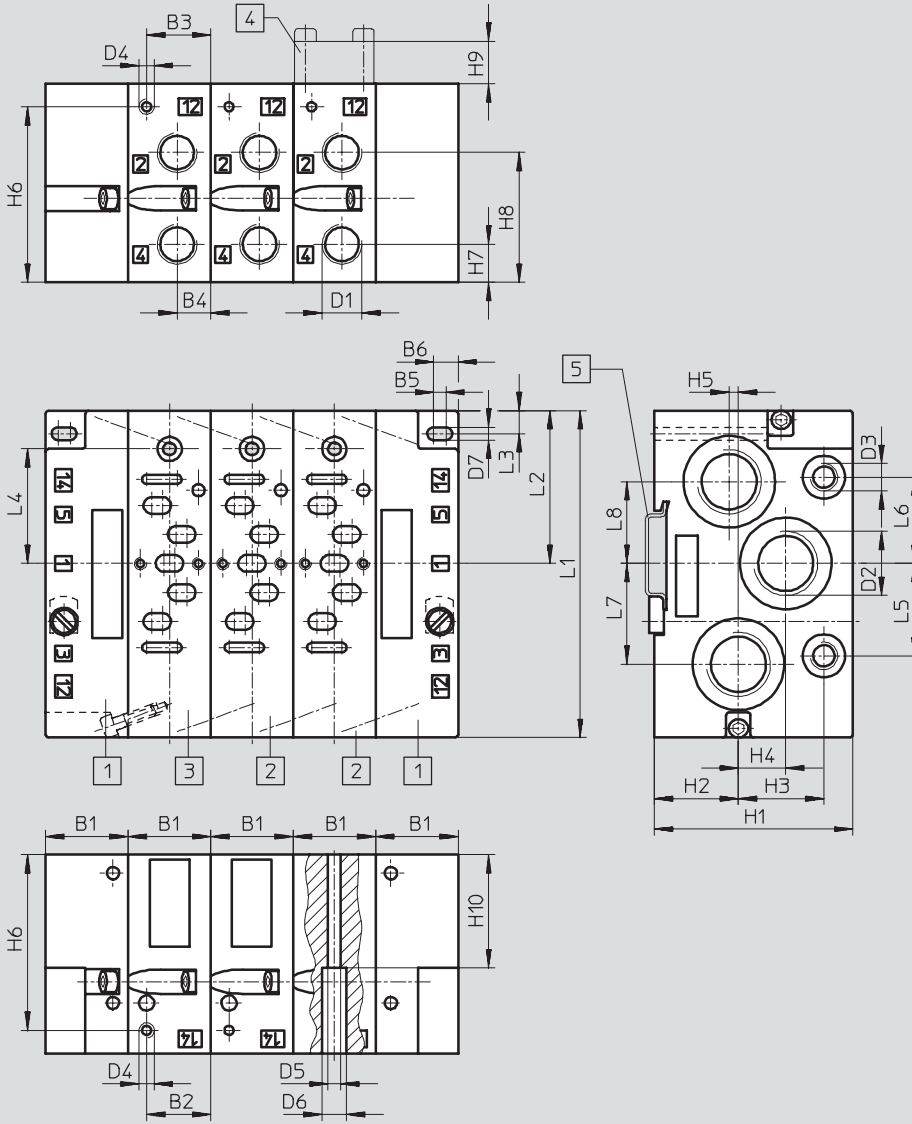

- 1 End plate kit
NEV-...VDMA
→ 2 / 1.3-44
- 2 Manifold sub-base
NAW-...-VDMA
→ 2 / 1.3-44
- 3 Manifold sub-base
NAW-...-VDMA-VL
→ 2 / 1.3-44
- 4 Blanking plate
NDV-...-VDMA
→ 2 / 1.3-51
- 5 Mounting rail
NRH-35-2000
→ 2 / 7.8-1

Note

For design reasons, only the silencer U-3/8-B can be screwed into ports 3 and 5 when assembling mounting rails with a width of 18 mm.

Width [mm]	B1	B2	B3	B4	B5	B6	D1	D2	D3	D4
18	19	6	13	7.5	1	4.5	G1/8	G3/8	G1/8	M5
26	27	21	21	11	4	8	G1/4	G1/2	G1/8	M5

Width [mm]	D5	D6	D7	H1	H2	H3	H4	H5	H6	H7
18	3.3	6.3	4.3	55	17	28.8	18.5	–	48	10.5
26	4.2	8	4.2	65	27.5	28	15.5	3	57.5	12.5

Width [mm]	H8	H9	H10	L1	L2	L3	L4	L5	L6	L7	L8
18	35.5	12	40	81	36.5	5.6	30.9	20	20	18	18
26	42.5	14	37	107	50	7.5	37.5	30.3	28.3	33	26.8

Manifold components, ISO 15407-1

Horizontal stacking



Dimensions – Manifold assembly, width 26 mm

Download CAD data → www.festo.com/en/engineering

Valves with central plug M8x1, M12x1

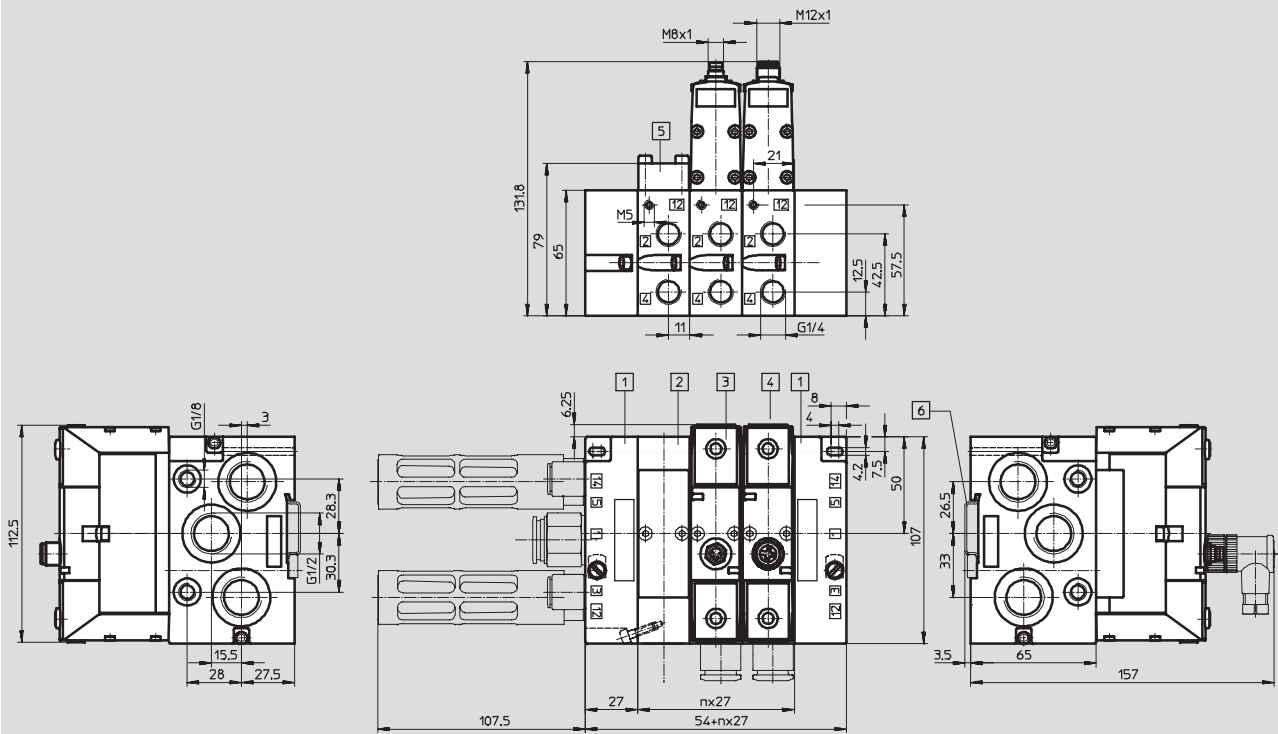

- | | | | |
|--|---------------------------------------|------------------------------|-----------------------------|
| 1 End plate kit
type NEV-01-VDMA | 3 Solenoid valve VSVA
(plug M8x1) | 5 Blanking plate NDV-01-VDMA | 6 Mounting rail NRH-35-2000 |
| 2 Manifold sub-bases
type NAW-1/4-01-VDMA | 4 Solenoid valve VSVA
(plug M12x1) | | |

Manifold components, ISO 15407-1

Horizontal stacking



Dimensions – Manifold assembly, width 26 mm

Download CAD data → www.festo.com/en/engineering

Valves with square plug, type C

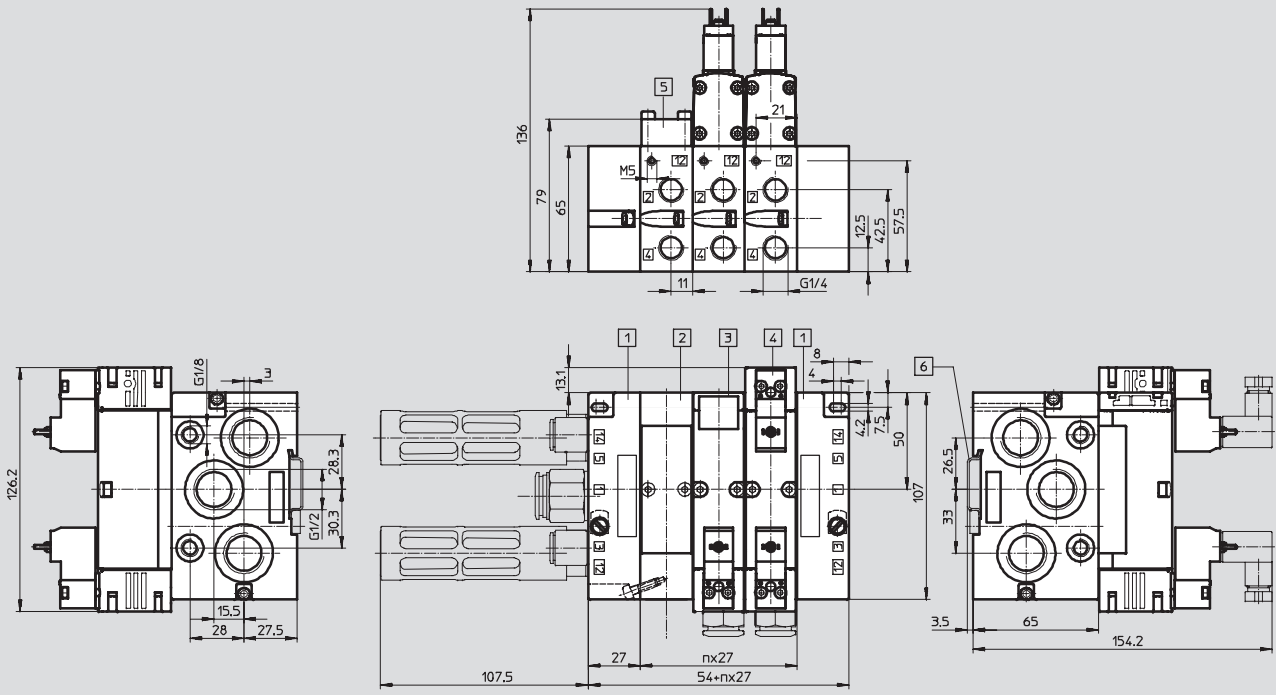

- | | | | |
|--|--|------------------------------|-----------------------------|
| 1 End plate kit
type NEV-01-VDMA | 3 Solenoid valve VSVA
(single solenoid) | 5 Blanking plate NDV-01-VDMA | 6 Mounting rail NRH-35-2000 |
| 2 Manifold sub-bases
type NAW-1/4-01-VDMA | 4 Solenoid valve VSVA
(double solenoid) | | |

Manifold components, ISO 15407-1

Horizontal stacking



Dimensions – Manifold assembly, width 18 mm

Download CAD data → www.festo.com/en/engineering

Valves with central plug M8x1

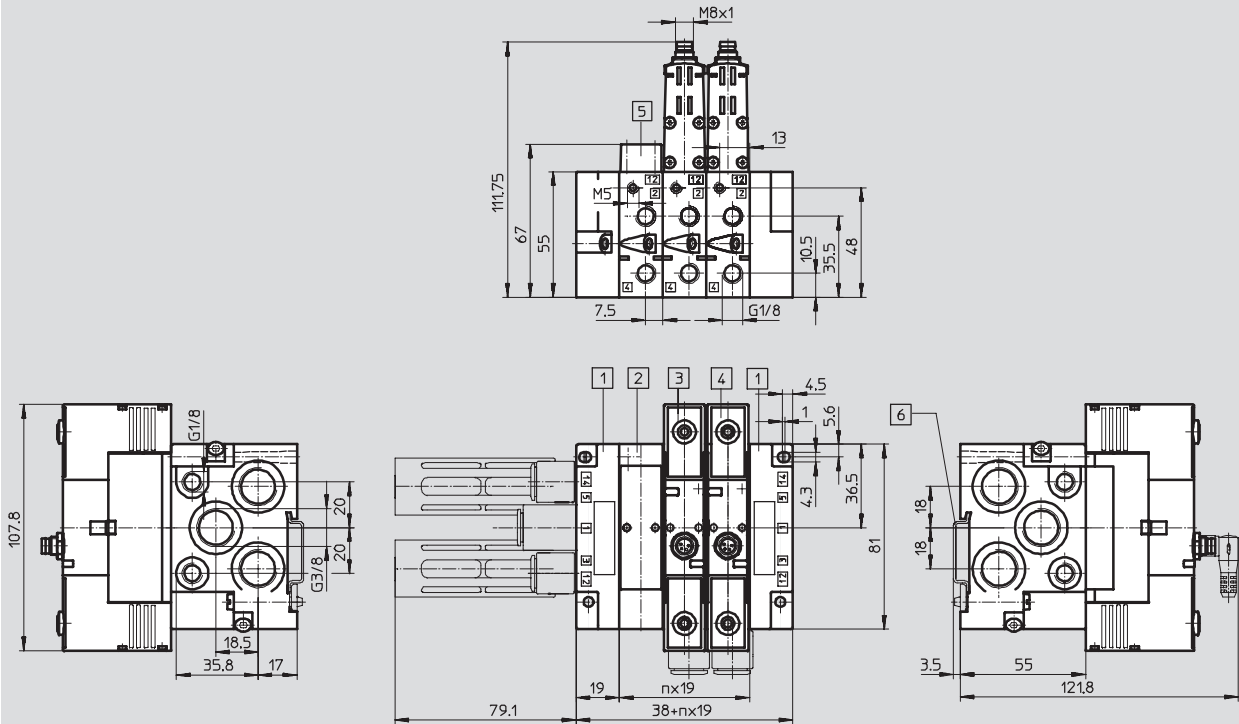

- | | | | |
|--|--------------------------------------|------------------------------|-----------------------------|
| 1 End plate kit
type NEV-02-VDMA | 3 Solenoid valve VSVA
(plug M8x1) | 5 Blanking plate NDV-02-VDMA | 6 Mounting rail NRH-35-2000 |
| 2 Manifold sub-bases type
NAW-1/8-02-VDMA | 4 Solenoid valve VSVA
(plug M8x1) | | |

Standard directional control valves
ISO 15407-1
1.3

Manifold components, ISO 15407-1

Horizontal stacking



Dimensions – Manifold assembly, width 18 mm

Download CAD data → www.festo.com/en/engineering

Valves with square plug, type C

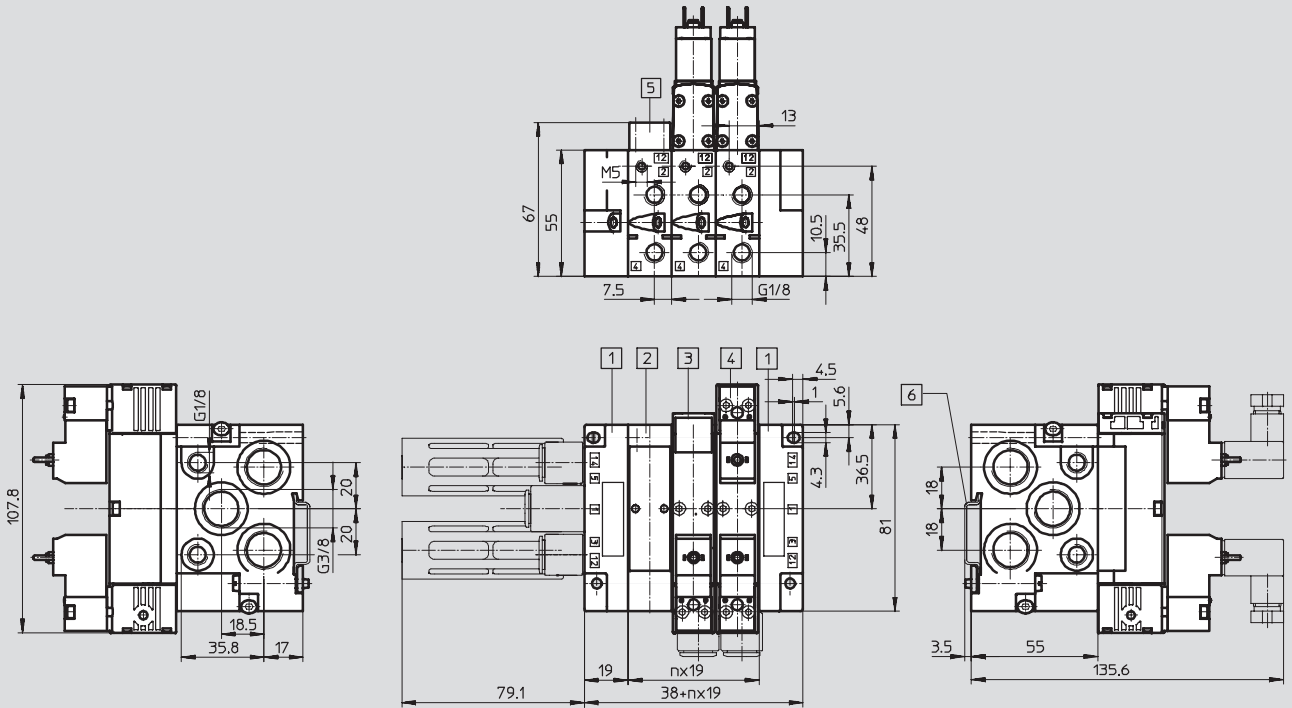

- | | | | |
|--|--|------------------------------|-----------------------------|
| 1 End plate kit
type NEV-02-VDMA | 3 Solenoid valve VSVA
(single solenoid) | 5 Blanking plate NDV-02-VDMA | 6 Mounting rail NRH-35-2000 |
| 2 Manifold sub-bases type
NAW-1/8-02-VDMA | 4 Solenoid valve VSVA
(double solenoid) | | |

Manifold components, ISO 15407-1

Horizontal stacking

Isolating disc NSC

Material:
Aluminium

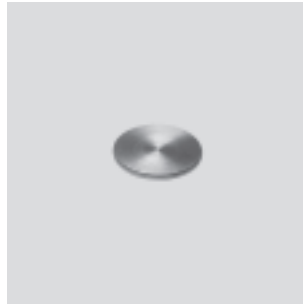

Ordering data – NSC for ports 1, 2, 3 (solenoid/pneumatic valves)			
Width [mm]	Weight [g]	Part No.	Type
18	2	161 113	NSC- $\frac{3}{8}$ -02-VDMA
26	2	161 105	NSC- $\frac{1}{2}$ -01-VDMA

Ordering data – NSC for ports 12, 14 (pneumatic valves)			
Width [mm]	Weight [g]	Part No.	Type
18	2	161 106	NSC- $\frac{1}{8}$ -01-VDMA
26	2	161 106	NSC- $\frac{1}{8}$ -01-VDMA

Blanking plate NDV

Material:
Polymer
Free of copper and PTFE

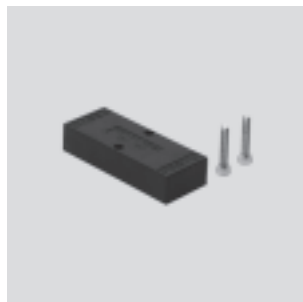

Ordering data			
Width [mm]	Weight [g]	Part No.	Type
18	22	161 114	NDV-02-VDMA
26	36	161 107	NDV-01-VDMA

Dimensions → 2 / 1.1-68

Manifold components, ISO 15407-1

Vertical stacking – Width 26 mm

Regulator plate VABF-S3-1-R ...

Material:
Housing: Die-cast aluminium
Control section: Polyamide

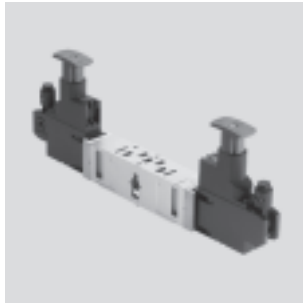

Dimensions Download CAD data → www.festo.com/en/engineering

A regulator (reversible), B regulator (reversible), AB regulator (reversible), P regulator

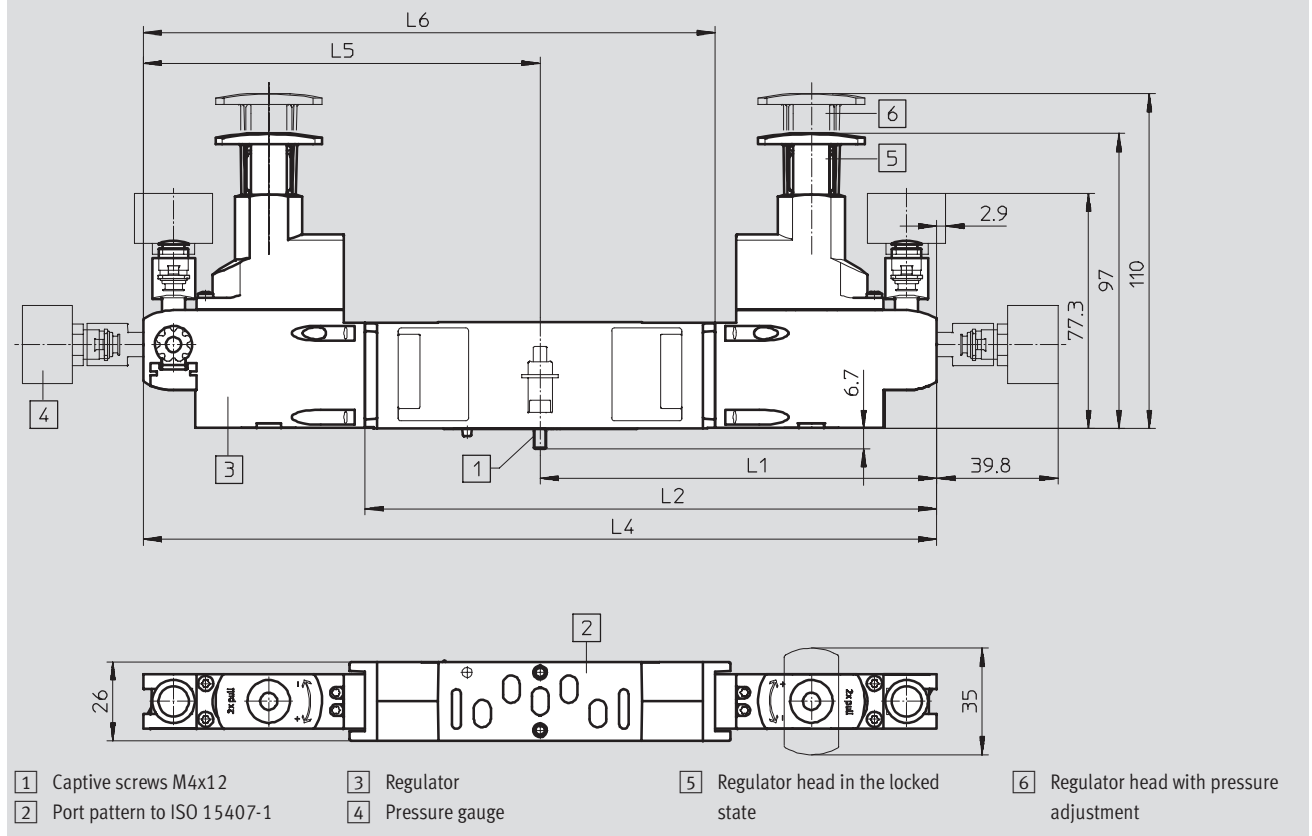

Dimensions							
Type	L1	L2	L3	L4	L5	L6	Weight [g]
VABF-S3-1-R5...	130.35	–	–	260.7	–	–	712
VABF-S3-1-R7...	–	–	–	–	130.35	192.9	452
VABF-S3-1-R6...	130.35	195	–	–	–	–	452
VABF-S3-1-R1...	130.35	183.88	–	–	–	–	439

Standard directional control valves
ISO 15407-1
1.3

Manifold components, ISO 15407-1

Vertical stacking – Width 26 mm

Dimensions – Width Download CAD data → www.festo.com/en/engineering

A regulator (reversible), B regulator (reversible), AB regulator (reversible), P regulator

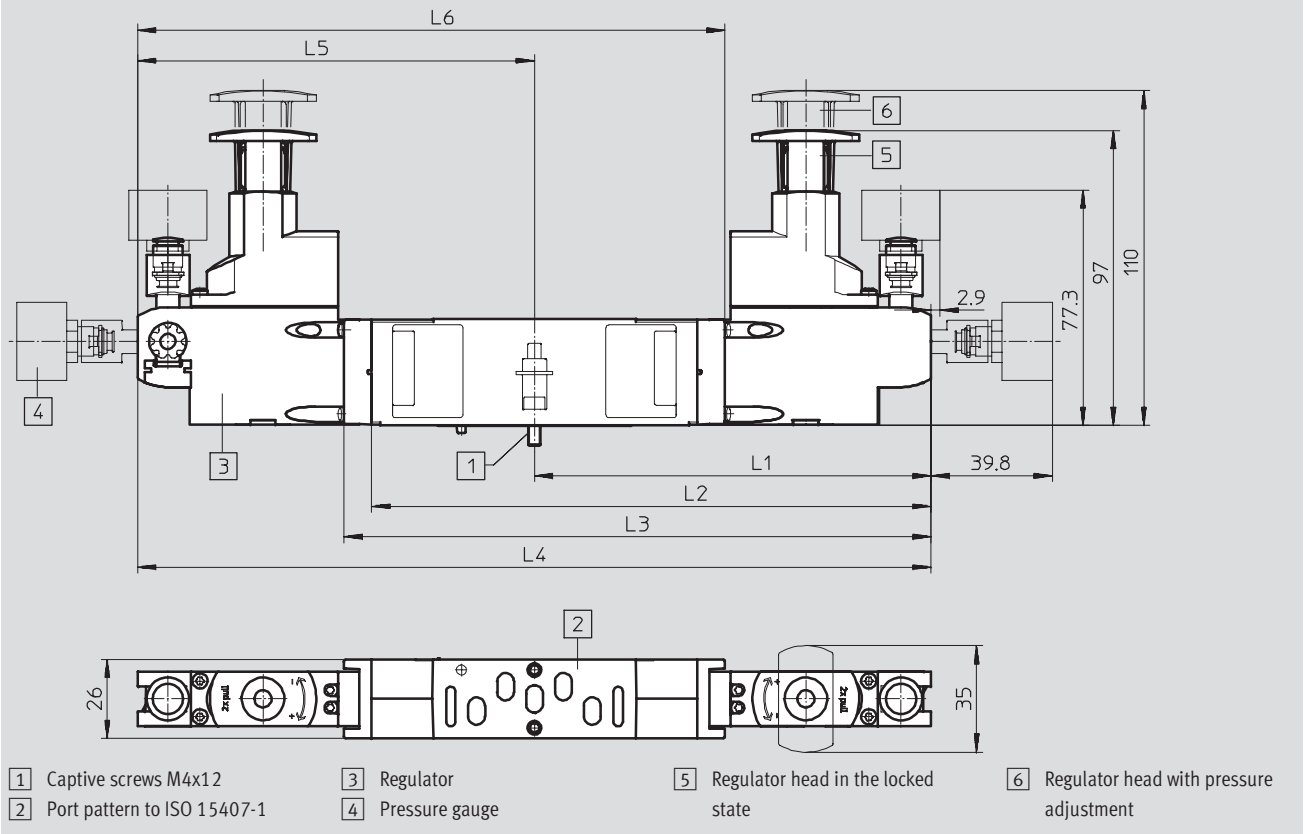

Dimensions							
Type	L1	L2	L3	L4	L5	L6	Weight [g]
VABF-S3-1-R4...	130.35	-	-	260.7	-	-	712
VABF-S3-1-R3...	-	-	-	-	130.35	192.9	452
VABF-S3-1-R2...	130.35	-	192.9	-	-	-	452

Standard directional control valves
ISO 15407-1
1.3

Manifold components, ISO 15407-1

Vertical stacking – Width 26 mm

Dimensions Download CAD data → www.festo.com/en/engineering

With manifold sub-base and solenoid valve (central plug)

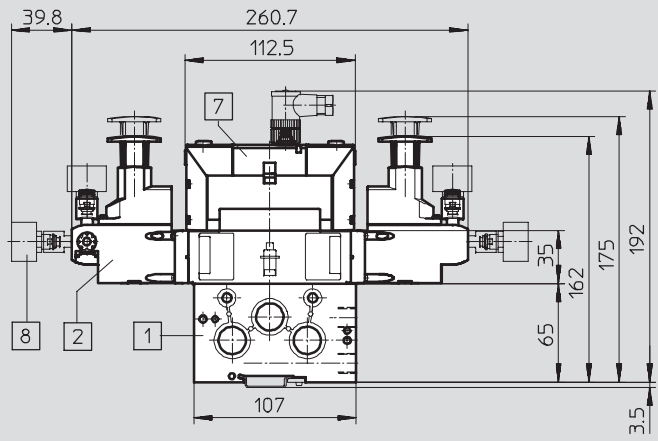

- 1 Manifold sub-base NAW
- 2 Pressure regulator plate
- 7 Solenoid valve VSVA
- 8 Pressure gauge, freely positionable

Dimensions Download CAD data → www.festo.com/en/engineering

With manifold sub-base and solenoid valve (plug type C)

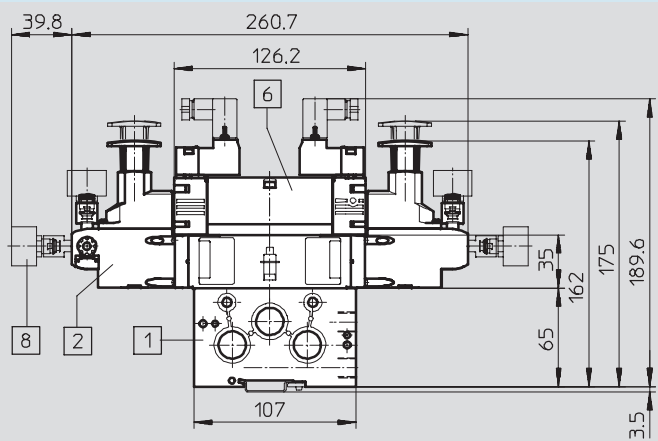

- 1 Manifold sub-base NAW
- 2 Pressure regulator plate
- 6 Solenoid valve VSVA
- 8 Pressure gauge, freely positionable

Ordering data

Designation	Description	Width	Part No.	Type
Regulator plate				
	For port 1, 10 bar	26 mm	543 527	VABF-S3-1-R1C2-C-10
	For port 1, 6 bar	26 mm	543 525	VABF-S3-1-R1C2-C-6
	For port 4, 10 bar	26 mm	543 531	VABF-S3-1-R3C2-C-10
	For port 4, 6 bar	26 mm	543 529	VABF-S3-1-R3C2-C-6
	For port 2, 10 bar	26 mm	543 535	VABF-S3-1-R2C2-C-10
	For port 2, 6 bar	26 mm	543 533	VABF-S3-1-R2C2-C-6
	For ports 2 and 4, 10 bar	26 mm	543 539	VABF-S3-1-R4C2-C-10
	For ports 2 and 4, 6 bar	26 mm	543 537	VABF-S3-1-R4C2-C-6
	For ports 2 and 4, reversible, 10 bar	26 mm	543 543	VABF-S3-1-R5C2-C-10
	For ports 2 and 4, reversible, 6 bar	26 mm	543 541	VABF-S3-1-R5C2-C-6
	For port 2, reversible, 10 bar	26 mm	546 789	VABF-S3-1-R6C2-C-10
	For port 2, reversible, 6 bar	26 mm	546 787	VABF-S3-1-R6C2-C-6
	For port 4, reversible, 10 bar	26 mm	546 793	VABF-S3-1-R7C2-C-10
	For port 4, reversible, 6 bar	26 mm	546 791	VABF-S3-1-R7C2-C-6

Manifold components, ISO 15407-1

Vertical stacking – Width 26 mm

FESTO

Flow control plate VABF-S3-1-F...

Material:
Housing: Die-cast aluminium

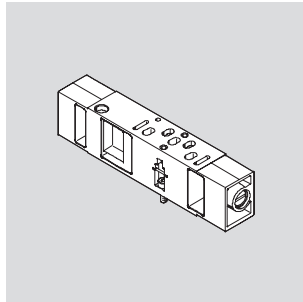

Dimensions

Download CAD data → www.festo.com/en/engineering

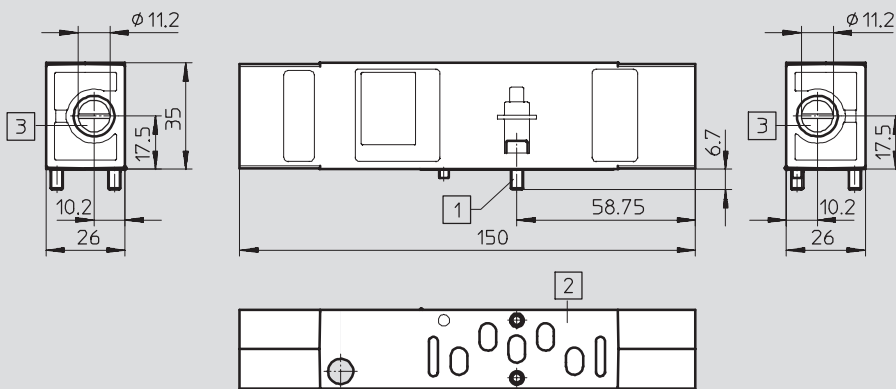

- 1 Captive screws M4x12
- 2 Port pattern to ISO 15407-1
- 3 Regulating screws

Standard directional control valves
ISO 15407-1

1.3

Dimensions

Download CAD data → www.festo.com/en/engineering

With manifold sub-base and solenoid valve (central plug)

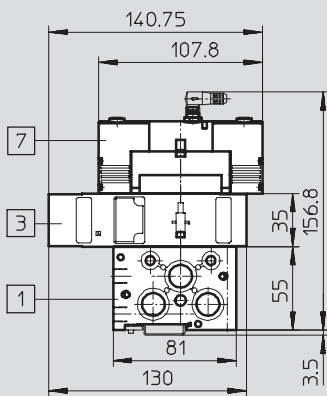

- 1 Manifold sub-base NAW
- 3 Throttle plate
- 7 Solenoid valve VSVA (central plug)

With manifold sub-base and solenoid valve (plug type C)

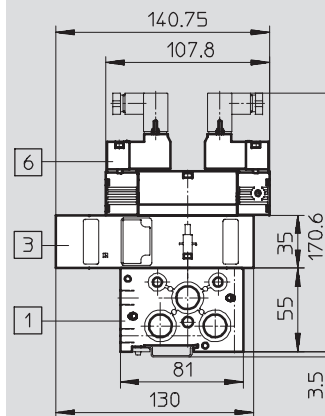

- 1 Manifold sub-base NAW
- 3 Flow control plate
- 6 Solenoid valve VSVA (plug type C)

Ordering data

Description	Width [mm]	Weight [g]	Part No.	Type
For exhaust air flow control in ducts 3 and 5 on the valve	26	320	543 604	VABF-S3-1-F1B1-C

Manifold components, ISO 15407-1

Vertical stacking – Width 26 mm

Vertical supply plate

VABF-S3-1-P ...

Material:

Housing: Die-cast aluminium

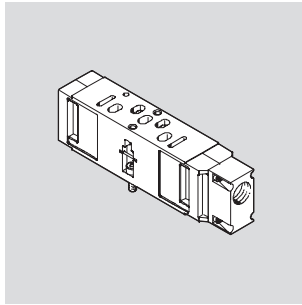

Dimensions

Download CAD data → www.festo.com/en/engineering

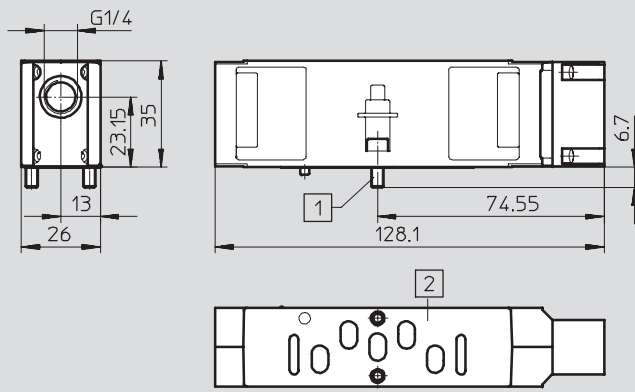

- 1 Captive screws M4x12
- 2 Port pattern to ISO 15407-1

Dimensions

Download CAD data → www.festo.com/en/engineering

With manifold sub-base and solenoid valve (central plug)

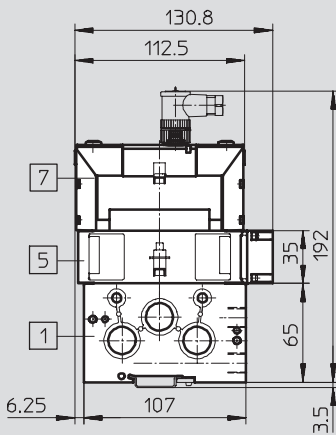

- 1 Manifold sub-base NAW
- 5 Vertical supply plate
- 7 Solenoid valve VSVA (central plug)

With manifold sub-base and solenoid valve (plug type C)

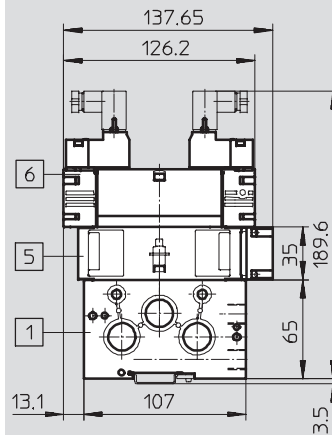

- 1 Manifold sub-base NAW
- 5 Vertical supply plate
- 6 Solenoid valve VSVA (plug type C)

Ordering data

Description	Width [mm]	Weight [g]	Part No.	Type
For the independent supply of a valve	26	201	544 434	VABF-S3-1-P1A3-G14

Manifold components, ISO 15407-1

Vertical stacking – Width 26 mm



Vertical pressure isolating plate VABF-S3-1-L ...

Material:
Housing: Die-cast aluminium

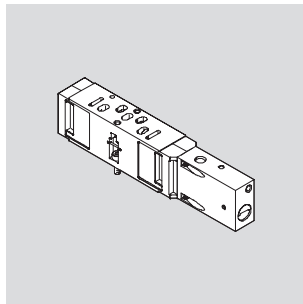

Dimensions

Download CAD data → www.festo.com/en/engineering

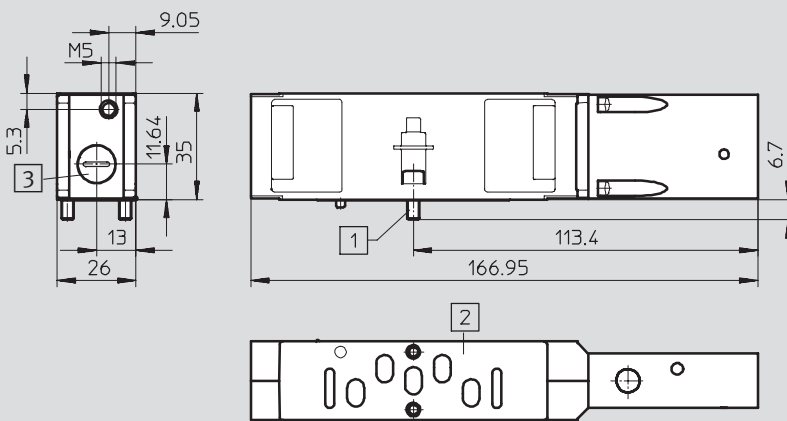

- 1 Captive screws M4x12
- 2 Port pattern to ISO 15407-1
- 3 Regulating screws

Dimensions

Download CAD data → www.festo.com/en/engineering

With manifold sub-base and solenoid valve (central plug)

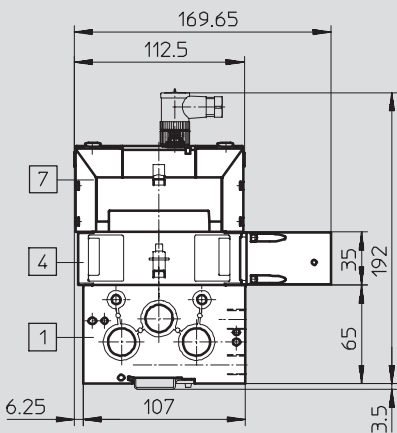

- 1 Manifold sub-base NAW
- 4 Vertical pressure isolating plate
- 7 Solenoid valve VSVA (central plug)

With manifold sub-base and solenoid valve (plug type C)

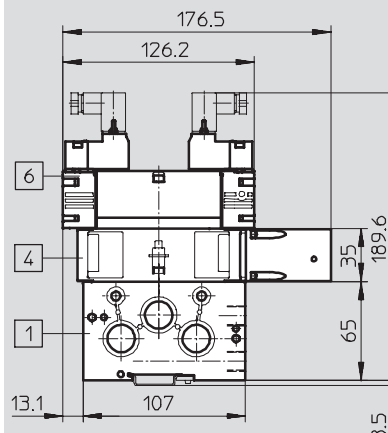

- 1 Manifold sub-base NAW
- 4 Vertical pressure isolating plate
- 6 Solenoid valve VSVA (plug type C)

Ordering data

Description	Width [mm]	Weight [g]	Part No.	Type
For shutting off a valve from the supply pressure	26	286	543 602	VABF-S3-1-L1D1-C







Solenoid/pneumatic valves, ISO 15407-1



Accessories

FESTO

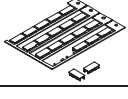
Standard directional control valves
ISO 15407-1

1.3

Ordering data		Part No.	Type
Pressure gauge		Technical data → Volume 3	
	With cartridge connection for regulator, 10 bar	543 487	PAGN-26-16-P10
	With cartridge connection for regulator, 6 bar	543 488	PAGN-26-10-P10
Cartridge fitting for regulator plate			
	For tubing O.D. 4 mm	172 972	QSP10-4
	For tubing O.D. 3/16"	172 975	QSP10-3/16U
Blanking plug		Technical data → Volume 3	
	Pack of 10	3570	B-3/8
Silencer			
	-	→ Volume 3	
Inscription label			
	Inscription label for valves VSVA (24 in frames included in scope of delivery)	18 182	IBS-9x20
Inscription label holder			
	Clip-on inscription label holder for valve cap (pack of 5)	540 888	ASCF-T-S6
	Inscription label holder for manifold blocks (pack of 5)	540 889	ASCF-M-S6

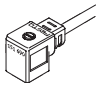
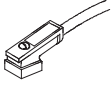

Ordering data – Plug sockets, plug sockets with cable for plug pattern DIN EN 175301-803, type C					
	Voltage [V]	Cable length [m]	Switching status display With LED	Part No.	Type
Plug socket without cable					
Technical data → 2 / 7.2-10					
	-	-	-	151 687	MSSD-EB
	-	-	-	539 712	MSSD-EB-M12
Plug socket without cable with insulation displacement technology					
Technical data → 2 / 7.2-10					
	-	-	-	192 745	MSSD-EB-S-M14
Plug socket with cable					
Technical data → 2 / 7.3-24					
	24 DC	2.5	■	151 688	KMEB-1-24-2,5-LED
	24 DC	5	■	151 689	KMEB-1-24-5-LED
	24 DC	10	■	193 457	KMEB-1-24-10-LED
	to 240	2.5	-	151 690	KMEB-1-230AC-2,5
	to 240	5	-	151 691	KMEB-1-230AC-5
	24 DC	2.5	■	174 844	KMEB-2-24-2,5-LED
	24 DC	5	■	174 845	KMEB-2-24-5-LED
	to 240	2.5	-	174 846	KMEB-2-230-2,5
	to 240	5	-	174 847	KMEB-2-230-5



Solenoid/pneumatic valves, ISO 15407-1



Accessories

FESTO

Ordering data – Illuminating seal for plug pattern DIN EN 175301-803, type C				Technical data → 2 / 7.4-1	
	Voltage		Part No.	Type	
	[V DC]	[V AC]			
	12 ... 24	–	151 717	MEB-LD-12-24DC	
	–	230	151 718	MEB-LD-230AC	

Ordering data – Plug sockets, plug sockets with cable for valves with central plug M12x1				Technical data → 2 / 7.2-10	
	Voltage	Cable length [m]	Part No.	Type	
	–	–	185 498	SEA-M12-4WD-PG7	
Plug socket with cable					
	–	1	185 499	KM-12-M12-GSWD-1-4	

Ordering data – Plug sockets with cable M12x1 for VSVA valves						Technical data → Volume 4	
	Assembly	Connection	Switching output		Cable length [m]	Part No.	Type
			PNP	NPN			
Straight plug socket							
	Union nut M12x1	4-pin	■	■	5	164 259	SIM-M12-4GD-5-PU
Angled plug socket							
	Union nut M12x1	4-pin	■	■	5	164 258	SIM-M12-4WD-5-PU

Ordering data – Plug sockets with cable M8x1 for VSVA valves						Technical data → Volume 4	
	Assembly	Connection	Switching output		Cable length [m]	Part No.	Type
			PNP	NPN			
Straight plug socket							
	Union nut M8x1	4-pin	■	■	2.5	158 960	SIM-M8-4GD-2,5-PU
					5	158 961	SIM-M8-4GD-5-PU
Angled plug socket							
	Union nut M8x1	4-pin	■	■	2.5	158 962	SIM-M8-4WD-2,5-PU
					5	158 963	SIM-M8-4WD-5-PU

Standard directional control valves
ISO 15407-1

1.3