

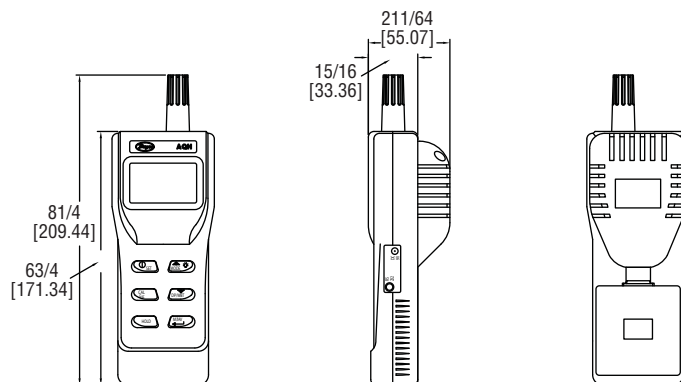

Model AQH-20 Handheld Indoor Air Quality Meter

Specifications - Installation and Operating Instructions



The Model AQH-20 Indoor Air Quality Meter reduces the number of instruments a contractor has to carry by measuring the carbon dioxide concentration, air temperature, and humidity in one device. A large backlit LCD display shows all three parameters simultaneously. The Model AQH-20 can display dew point, or wet bulb temperatures in place of the ambient temperature. Minimum, maximum, and average readings are easily accessible through the function buttons. By pressing the hold key, the current values are held so that they can be recorded. An audible alarm warns the user that the current ambient conditions are becoming hazardous. The Model AQH-20 includes a hard carrying case and four AA alkaline batteries.

OPERATING INSTRUCTIONS

Taking Measurements

Press the  button to turn the meter on. The meter takes 30 seconds to warm up before displaying the current reading.



CO2 measurement is shown in top display

Air temperature, dew point, or wet bulb temperature is shown in lower left display

Humidity measurement is shown in lower right display

NOTICE

When Model AQH-20 experiences a large variation in environment, the meter may take 30 seconds to respond.

Press the  button for at least one second, to activate backlight. Do the same to turn off the backlight.

SPECIFICATIONS

Measurement Ranges:

CO2: 0 to 2000 ppm.

Temperature: 14 to 140°F (-10 to 60°C).

Relative Humidity: 0.0 to 99.9% RH.

Accuracy:

CO2: ±30 ppm ±5% of reading;

Temperature: ±0.9°F (±0.6°C);

Humidity: ±3% RH (10 to 90%), ±5% (0.0 to 9.9% or 90 to 99.9%).

Resolution:

CO2: 1 ppm;

Temperature: 0.1°F (0.1°C);

Humidity: 0.1% RH.

Response Time:

CO2: < 30 seconds;

Temperature: < 2 minutes;

Humidity: <10 minutes.

Display: Four digits for temperature/CO2 and 3 digits for humidity.

CO2 Sensor: Non-dispersive infrared.

Operating Temperature: 32 to 122°F (0 to 50°C).

Operating Humidity (Non-Condensing): 0 to 95% RH.

Power Requirements: Four AA alkaline batteries.

Warm Up Time: 30 seconds.

Weight: 6.76 oz (200 g).

Agency Approval: CE.



Selection of Temperature Parameter



The Model AQH-20 can display ambient air temperature, dew point temperature, or the wet bulb temperature. Press the  button to cycle between air temperature, dew point temperature, and wet bulb temperature. The temperature and measurement type will be displayed in the lower left corner of the display.

Changing the CO2 Alarm Set Point

Hold down  for more than one second during normal mode.

When "Al" and "P1.0" are displayed on the LCD, press the  button to enter alarm setup mode.

The current alarm value will be blinking on the LCD. "Al and P1.0" will be displayed on the bottom displays. Press the  button to increase the value and press the  button to decrease the value.

When desired value is reached, press the  button to save the value and return to the main menu or press  button to return to main menu without saving the changes.

If the alarm sounds, simply press any key (but power key) to silence the alarm.

Changing Engineering Units

Hold down  for more than one second during normal mode to reach the main menu.

Press the  or the  to toggle between alarm setup and unit setup.

When "Units" and "P3.0" are displayed on the LCD, press the  button to enter engineering unit setup.

The current temperature unit will be blinking on the lower left of the display. Press the  or the  to toggle between Celsius and Fahrenheit.

When desired unit is set, press the  button to save and return to the main menu or press  button to return to the main menu without saving the changes.

Holding the Current Value

Press and release the  to freeze the primary temperature display. "HOLD" will appear at the top left of the screen.

In order to return to normal operation, press the  button again and the "HOLD" icon disappears from the display.

Max, Min, and Average Data Functions

Press the  button to cycle through the MIN, MAX, STEL, and TWA functions. To exit, cycle through until none of the four mentioned functions appear on the screen.

MIN and MAX readings show the minimum and maximum CO2 readings on the main display, respectively. STEL and TWA readings show the weighted average of the CO2 readings on the main display. STEL uses all the CO2 readings from the past 15 minutes to calculate the average. TWA uses all the readings from the past 8 hours to calculate the average. The current temperature and humidity continues to be displayed at the bottom of the LCD.

NOTICE

Model AQH-20 requires at least 5 minutes worth of values in order to calculate either of the CO2 averages.

Automatic Power Off (Sleep Mode)

The instrument will shut off automatically after 20 minutes of operation to conserve battery life if no button is pressed. To disable the sleep mode, press "Ø set" and the "HOLD" buttons simultaneously before power on. An "n" icon will appear in the center of the display once disabled.

BATTERY REPLACEMENT

The Air Quality Handheld displays  as a visual low battery indication.

When "Lob" appears on the LCD and a beeper sounds, the batteries must be replaced.

NOTICE

If the unit fails to power on, it is likely that the batteries also need to be replaced.

To Replace the Battery:

1. Make sure the unit is powered off.
2. Lay face down on a clean, flat surface.
3. Open battery compartment by pushing in tab and lifting cover.
4. Replace battery, taking note of the indicated polarity.
5. Replace the cover.



NOTICE

Failing to turn the handheld off may result in malfunction of the unit. Dispose of used batteries promptly and keep away from children.

CO2 Calibration

The CO2 sensor should be calibrated in fresh outdoor air that is well ventilated and in good weather conditions. Do not calibrate in areas with high CO2 concentrations such as crowded areas.

Procedure:

1. Place meter in the calibration site.
2. Turn the unit on and hold down  and  simultaneously to enter CO2 calibration mode.
3. "400ppm" and "CAL" should be blinking on the display.
4. Wait 10 minutes until the blinking stops and the unit returns to normal mode.

To abort the calibration, turn the meter off at any time.



RH Calibration

NOTICE

The RH calibration should be done at 25°C and humidity close to the calibration salt being used (must at least be stable).



The RH must be calibrated with the default calibration salt. If not done properly and with the correct salts, it will cause permanent damage.

33% Calibration Procedure:

1. Plug sensor probe into 33% salt bottle.
2. Hold down  and  under normal mode to enter 33% calibration.
3. "CAL" and the calibrating value should be blinking on the LCD with current temperature displayed but not blinking.
4. Wait about 60 minutes until "CAL" and the calibrating value stop blinking.

75% Calibration Procedure:

1. After 33% calibration, plug the sensor probe into 75% salt bottle.
2. Press the  button to enter 75% calibration mode.
3. "CAL" and the calibrating value should be blinking on the LCD with current temperature displayed but not blinking.
4. Wait about 60 minutes until "CAL" and the calibrating value stop blinking and the meter returns to normal mode.

Users can also calibrate either calibration point individually. For the 33% calibration point, press the  once the 33% calibration is complete. For the 75% calibration point, press the  or  within the first five minutes while initializing the 33% calibration.

MAINTENANCE

A periodic check of the system calibration is recommended. Model AQH-20 is not field serviceable and should be returned if repair is needed (field repair should not be attempted and may void warranty). Be sure to include a brief description of the problem plus any relevant application notes. Contact customer service to receive a return goods authorization number before shipping.