

Eddy Current Non-ferrous Metal Separators

Permanent Rare Earth Magnetic

*Removes non-ferrous
metallics from:*

- *plastics*
- *glass cullet*
- *electronic scrap*
- *automobile shredder
residue (ASR)*
- *boiler bottom ash*
- *spent foundry
core sand*
- *municipal solid
waste (MSW)*
- *co-mingled
recyclables*
- *urban wood waste*
- *mixed metals.*



In 1969, Eriez Magnetics patented both permanent magnetic and electromagnetic eddy current separators. These powerful systems feature improved permanent magnetic circuits with Rare Earth Erium® 3000 for stronger eddy currents and improved separation of non-ferrous materials.

In operation, the non-ferrous separator utilizes permanent rare earth magnets to induce eddy currents into metallic particles. This produces repelling forces which separate the metallics from non-metallics, providing a cleaner product for further processing. Removal of the metallics is selective and product loss is minimized.

FEATURES

- Stronger eddy current fields. Eriez draws upon its expertise in magnetics to develop a more powerful separator than competitive units
- Each eddy current non-ferrous separator designed for your application. Single-source dependability and overall system integrity
- Utilizes a high-gradient Erium® 3000 Rare Earth permanent, non-electric magnetic rotor element for significant power savings. Erium 3000 is over 5 times stronger than conventional permanent magnets

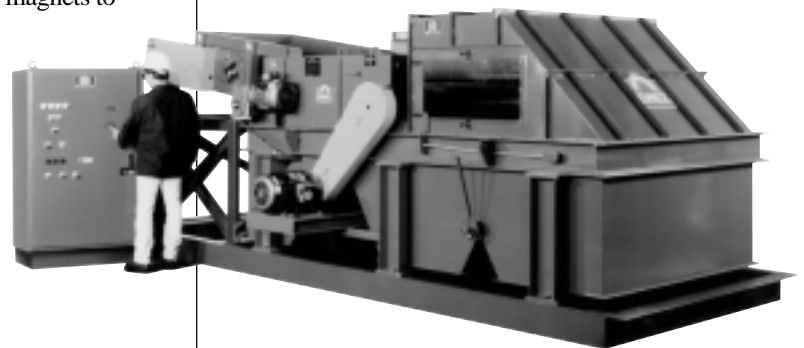

PRINCIPLES OF OPERATION

The non-ferrous metallic separator consists of an external drum, an internal permanent magnetic rotor, a drive, and belt conveyor.

The external drum shell of non-metallic composite material rotates at conventional belt conveyor speed. The internal concentric full diameter Rare Earth alternating polarity rotor turns at much higher RPM than the external shell

Through the induction of eddy currents and the resulting repelling forces, the alternating magnetic field selectively repels the non-ferrous metals and physically separates them from other materials with minimum product loss.

A uniform feed to the Eddy increases capacity and recovery.

Eriez heavy-duty vibratory feeders are capable of handling difficult materials. Low energy consuming electro-permanent magnetic or eccentric weight drives are used. Simple controls and AC operation increase productivity and reliability. Standard and special feeder trays are available.

ADDITIONAL FEATURES

- Feed widths up to 60-inches
- Compact overall dimensions for installation versatility
- Available with Eriez vibratory pan feeder, Rare Earth magnetic drum, and belt conveyor for processing different infeed materials
- Patented heavy duty Kevlar/ceramic surface rotor shell for long life
- A variety of rotor designs optimize non-ferrous removal. Ask about our NEW Super Eddy. A low cost ferrite rotor model is also available for repelling aluminum cans from co-mingled recyclables
- Hi-frequency eddy fields for optimal separation
- Urethane conveyor belt
- Self-cleaning
- Belt repair kit with heatgun

Various Eddy Current Separators in Operation

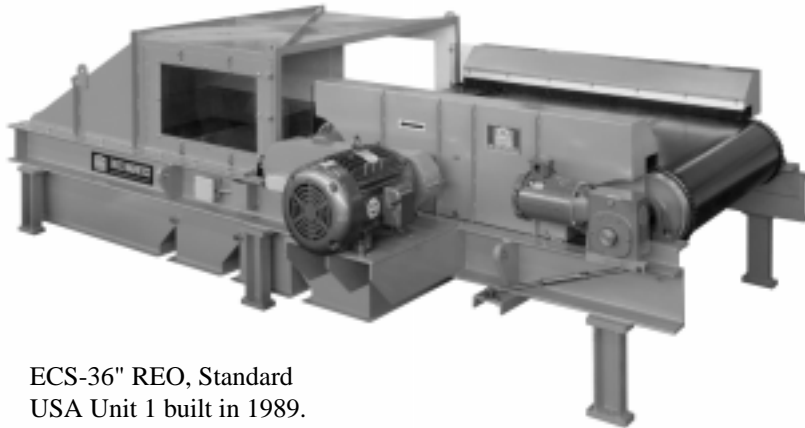

ECS-36" REO, Standard
USA Unit 1 built in 1989.
Industrial grade from the beginning.



ECS-24" REA, Type M
Removing used beverage cans (UBC) from household trash



ECS-12" REA, Laboratory Separator
Used for testing and pilot plant work.
Lexan sides allow full viewing.



ECS-48" REO, Type HD with HV Pan Feeder
Removing aluminum cans from municipal solid waste (MSW) at a material recovery facility.



Typical Eddy Current Separator
Control, NEMA 4 construction,
with rotor logic and VFD for Eddy
conveyor belt.



ECS-24" REO, Standard
Removing aluminum from glass cullet



ECS-24" REA, Type PET with Hopper and Feeder
Removes small aluminum contaminants and purifies
PET (plastic) flakes. An RE Roll Magnet fitted to the
right side removes weakly magnetic contaminants.

Eddy Current Separator Models

TYPE "M" EDDY

This streamlined design is ideal for material recovery facilities (MRF). It uses rugged 8-inch steel channel frame and legs, compact reinforced tapered hood, washdown motors, quick 20-second removable access panels, Lexan viewing window, and URO urethane conveyor belt. It can be equipped with FE or REA rotors. Eriez' pan feeders, chutes, and variable speed belt and rotor options are available. Inboard or outboard drives are available. The control is NEMA 12 with rotor logic and motor starters.

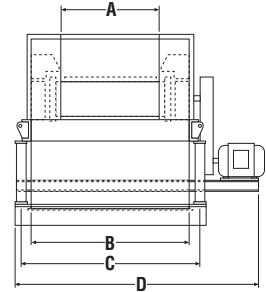
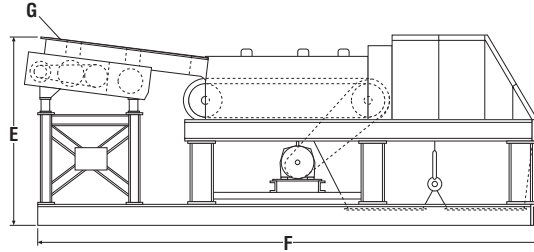

THE "STANDARD" EDDY

This is the Eddy all others are judged against. It has set the "industry standard". It is typically equipped with the REO rotor and is ideal for MSW and ASR applications. Its longer reinforced tapered hood has interlocked swingout Lexan doors and twin flanged discharge chutes with two way (vertical and angle) adjustable splitter included. The control is NEMA 4 with rotor logic.

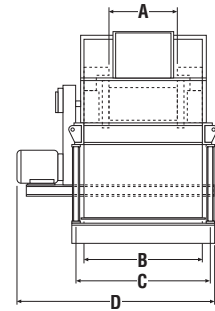
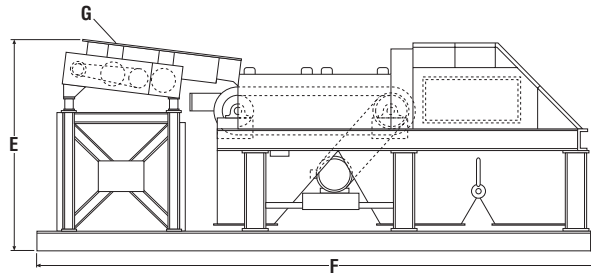

THE "HEAVY DUTY" EDDY

The HD framework is for dirty, dusty, gritty applications. The special extended sidecovers keep dirt out of the inner belt/rotor zone and an air purge pipe is standard. The discharge chutes have ARS liners and the splitter is beefier. The control is NEMA 4 with rotor logic and variable frequency drives (VFD) for the belt, rotor, and optional vibrating pan feeder.

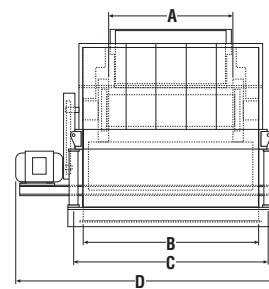
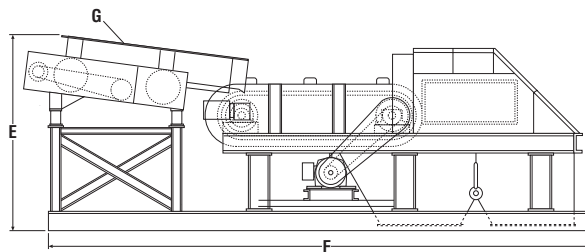

Separator Dimensions

INCHES/POUNDS

MODEL	A	B	C	D	E	F	G (L X W)	WEIGHT
M	24	45-3/4	53	63	69-1/4	185-1/4	60 X 20	6,420
	36	57-3/4	65	75	69-1/4	185-1/4	60 X 32	8,120
	48	69-3/4	77	87	69-1/4	185-1/4	60 X 44	10,500
	60	81-3/4	89	99	69-1/4	185-1/4	60 X 56	13,000
STD	24	45-3/4	53	76	81-5/8	224	60 X 20	7,000
	36	57-1/4	65	90	81-5/8	224	60 X 32	8,500
	48	69-3/4	77	103	81-5/8	224	60 X 44	10,700
	60	81-3/4	89	118	81-5/8	224	60 X 56	13,500
HD	24	45-3/4	53	76	81-5/8	224	60 X 20	7,000
	36	57-1/4	65	90	81-5/8	224	60 X 32	8,700
	48	69-3/4	77	103	81-5/8	224	60 X 44	11,000
	60	81-3/4	89	118	81-5/8	224	60 X 56	13,500

MILLIMETERS/KILOGRAMS

MODEL	A	B	C	D	E	F	G (L X W)	WEIGHT
M	610	1162	1346	1600	1759	4705	1524 X 508	2912
	914	1467	1651	1905	1759	4705	1524 X 813	3683
	1219	1772	1956	2210	1759	4705	1524 X 1118	4762
	1524	2077	2261	2515	1759	4705	1524 X 1422	5897
STD	610	1162	1346	1930	2073	5690	1524 X 508	3175
	914	1467	1651	2286	2073	5690	1524 X 813	3856
	1219	1772	1956	2616	2073	5690	1524 X 1118	4854
	1524	2077	2261	2997	2073	5690	1524 X 1422	6124
HD	610	1162	1346	1930	2073	5690	1524 X 508	3266
	914	1467	1651	2286	2073	5690	1524 X 813	3946
	1219	1772	1956	2616	2073	5690	1524 X 1118	4990
	1524	2077	2261	2997	2073	5690	1524 X 1422	6214

Rotor Designs

The Eddy Current Rotor is the heart of the separator. Eriez builds four different rotor designs: ferrite, Rare Earth arched (REA), Rare Earth Original (REO), and Super Eddy, for a multitude of applications. Now, rotors are available as separate items. All Eriez rotors use patented Kevlar/ceramic tile surface shells and grease retainer chambers. They typically are balanced to operate at 2500 RPM.



FERRITE (FAST EDDY)

This is the most economical rotor. While it uses conventional barium ferrite magnets, they are type 8C, the strongest available. It is ideal for separating aluminum, used beverage cans (UBC) from trash. Ferrite rotors can also separate various non-ferrous metals (NFM) such as aluminum, brass or lead from each other. The splitter gap for UBCs is 12 inches (305 mm).

RARE EARTH ARCHED (REA)

This is our “most popular” rotor. It uses powerful Rare Earth (Neodymium Boron Iron) magnets that are curved to fit the shell contour. This high-frequency rotor has 22 poles and offers exceptional removal of small and medium non-ferrous metals (NFM) from electronic scrap, plastics, glass cullet, foundry sand, and urban wood waste, as well as aluminum cans from MRFs. The splitter gap on UBCs is 18-20 inches (457-508 mm).

RARE EARTH ORIGINAL (REO)

This is a very powerful rotor. It uses large blocks of Rare Earth magnets to generate a deeper eddy current field. Its 16 pole design is excellent at recovering NFM from denser flows, like municipal solid waste (MSW) at dirty MRFs or automobile shredder residue (ASR) at car shredders. Its higher recoveries provide quicker paybacks. The splitter gap on UBCs is 24-30 inches (610-762 mm).

SUPER EDDY

This is the most powerful rotor available. It uses huge curved blocks of Rare Earth magnets to achieve over 5,000 gauss at the surface of the eddy current conveyor belt. It is for select high tonnage applications, where maximum recovery is required.

Rotor Dimensions

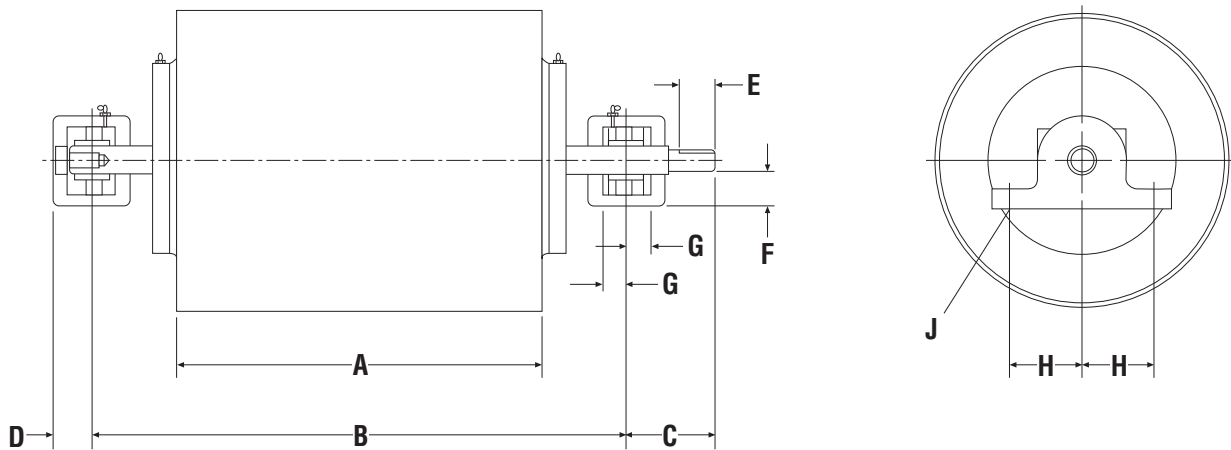



INCHES/POUNDS

GROUP	WIDTH	A	B	C	D	E	F	G	H	J	WEIGHT
1	12	20.44	29.25	9-1/16	2.82	6.65	3.15	1.57	4.63	5/8-16	368
2	24	32.44	41.25	9-1/16	2.82	6.65	3.15	1.57	4.63	5/8-16	507
3	36	44.44	53.25	9-1/16	2.82	6.65	3.15	1.57	4.63	5/8-16	646
4	48	56.44	65.25	9-1/16	2.82	6.65	3.15	1.57	4.63	5/8-16	785
5	60	66.44	75.5	11-5/16	3.5	8.10	4.40	2.87	5.70	3/4-10	1140

MILLIMETERS/KILOGRAMS

GROUP	WIDTH	A	B	C	D	E	F	G	H	J	WEIGHT
1	305	519	743	230	72	169	80	40	117	5/8-16	167
2	610	824	1048	230	72	169	80	40	117	5/8-16	230
3	914	1129	1353	230	72	169	80	40	117	5/8-16	293
4	1219	1434	1657	230	72	169	80	40	117	5/8-16	356
5	1524	1687	1918	287	89	206	112	73	145	3/4-10	517



Application Data

<p>ALUMINIUM USED BEVERAGE CANS (UBC) Recycling awareness has led many communities to build Material Recovery Facilities (MRFs) to recycle glass, plastic, paper, steel and aluminum. Belt, Pulley, and Drum Magnets remove the steel (tin cans), and Eddys remove the aluminum UBCs. This is more cost effective than using human labor.</p>		<p>TYPICAL PRODUCT: Municipal Solid Waste (MSW) or Co-mingled Household Recyclables</p> <p>MACHINE TYPE: Type M (for co-mingled recyclables) Type HD (for MSW)</p> <p>ROTOR TYPE: FEA, REA or REO</p> <p>TYPICAL CAP: 1 – 4 TPHPF</p>
<p>AUTOMOBILE SHREDDER RESIDUE (ASR) After car bodies are shredded, Drum, Belt, and Pulley Magnets remove the ferrous and Eddys are used to remove the remaining non-ferrous metals (NF). The ECS can recover 95% of the NF and raise the grade/purity from ~50% to 85-90%+.</p>		<p>TYPICAL PRODUCT: 3/16 x 3/8", 3/8 x 2", 2 x 6" ASR</p> <p>MACHINE TYPE: Type M or HD</p> <p>ROTOR TYPE: REA or REO</p> <p>TYPICAL CAP: 2 – 5 TPHPF</p>
<p>GLASS CULLET If metal particles remain in the cullet, they cause slight imperfections in the new glass products. The ECS is an effective way to reduce the NF contaminants without loss of good material, a dilemma seen when only metal detectors are used. Installing an ECS on the metal detector reject just makes good sense.</p>		<p>TYPICAL PRODUCT: 1/4 x 2", 3/8" Nominal Cullet</p> <p>MACHINE TYPE: Type M or Standard</p> <p>ROTOR TYPE: REA Hi-Frequency</p> <p>TYPICAL CAP: 5 TPHPF</p>

Capacities are recommended for best recovery. TPHPF = Ton Per Hour Per Foot of Eddy Width

Other typical applications: electronic scrap, scrap metals, wood waste, pot-lining and office paper.

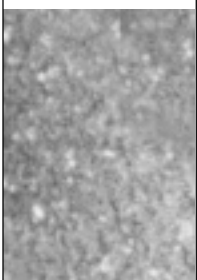
Application Data (continued)

<p>FOUNDRY SAND Hi-tech non-ferrous foundries, like aluminum, often use binders or resins in the sand cores. Spent sand cores do not go granular, so they cannot be separated in a delumper. The ECS repels the metal from the sand core chunks. The sand can be treated and re-used, or land filled at lower rates. The metal can be re-melted.</p>		<p>TYPICAL PRODUCT: +1/4 x 2" Core Sand (100°F) MACHINE TYPE: Type M or Standard ROTOR TYPE: REA Hi-Frequency TYPICAL CAP: 5 – 8 TPHPF</p>
<p>PET PLASTICS Polyethylene terephthalate (PET) is a plastic material used in beverage containers. The PET containers are shredded and washed. Special Eriez' Eddys remove small metal contaminants to purify the PET, so it can be re-used to make fiber, banding, or blended to make 'recycled content' containers.</p>		<p>TYPICAL PRODUCT: Washed 1/2" Flakes MACHINE TYPE: Special PET Eddy ROTOR TYPE: REA Hi-Frequency TYPICAL CAP: 1/2 – 3/4 TPHPF</p>
<p>BOTTOM ASH Many communities burn garbage or municipal solid waste (MSW) to generate steam and electricity. The bottom ash contains metals. Drum and Pulley Magnets remove ferrous metals. Eriez' Eddys remove the non-ferrous metals or 'nuggets' and some coins.</p>		<p>TYPICAL PRODUCT: 1/2 x 2" Ash Under 15° Moisture MACHINE TYPE: Type M or Standard ROTOR TYPE: REA Hi-Frequency TYPICAL CAP: 5 – 8 TPHPF</p>

Capacities are recommended for best recovery. TPHPF = Ton Per Hour Per Foot of Eddy Width

Other typical applications: electronic scrap, scrap metals, wood waste, pot-lining and office paper.

Other Eriez Recycling Equipment

MAGNETIC PULLEYS

Powerful axial interpole magnetic circuits separate ferrous from recycled products being conveyed on belt conveyors. Also used to remove ferrous prior to the Eddy Current.



DRUM SEPARATORS

Model HFP drum in housing separators provide controlled feed and discharge for automatic separation of ferromagnetic and paramagnetic particles. Available with conventional or powerful Rare Earth permanent drum magnets. Also available an open stand with drive.



SUSPENDED ELECTROMAGNETIC SEPARATORS

Automatically reclaims ferrous from product flows on conveyor belts or vibratory feeders to provide a salable product and/or protect downstream equipment. Armor clad self cleaning belt shown.

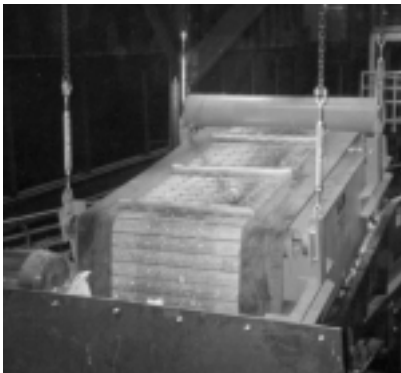

SUSPENDED PERMANENT MAGNET SEPARATORS

Remove large amounts of ferrous automatically from non-ferrous materials conveyed on almost any type of belt conveyor, pan feeder or chute.



MECHANICAL FEEDERS

Model HVF feeders are low profile, rugged, low horsepower, high capacity units for the controlled movement of recycled glass, sand, auto shredder residue (ASR), MSW, and plastic onto Eddy Current Separators. Screening decks available.

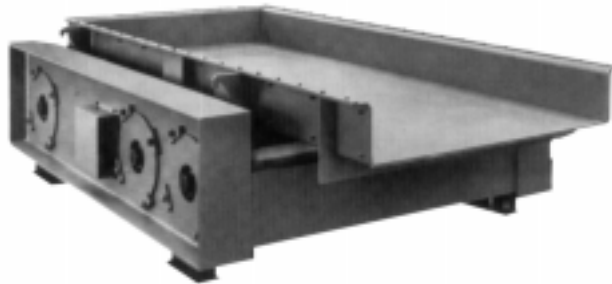

SCRAP DRUMS

Use deeper magnetic fields to reclaim ferrous materials in shredded car bodies, scrap metals, municipal solid waste, wood waste, slag, incinerator bottom ash, foundry sand and minerals processing applications.



ELECTROSTATIC SEPARATORS

Electrostatic Separators utilize surface conductivity to recover valuable metals from electronic scrap such as chopped wire, circuit boards, ACSR cable, chopped rotors, computer scrap and complex scrap.



METAL DETECTORS

Detect both ferrous and non-ferrous metal in recycled products like glass cullet, PET plastics and wood. Often used after and Eddy to enhance purity of these products.



Eriez Technical Center

ANALYZES SEPARATION AND PRODUCT MOVEMENT REQUIREMENTS

Industry's most complete magnetic and vibratory test facility is the Eriez Magnetics Technical Center. It utilizes equipment ranging from conventional plates, grates and traps to superconducting high gradient magnetic separators in determining the most effective ways to remove ferrous and non-ferrous contaminants, or to concentrate valuable minerals.

You are encouraged to participate in the testing of your materials as Eriez engineers and technicians seek the most effective solutions to your processing problems.

Call us to discuss your application challenges.



Dimensions and specifications are subject to change without notice.

Eriez, Eriez Magnetics and Erium are registered trademarks of Eriez Manufacturing Co.

©2002 ERIEZ MAGNETICS

ALL RIGHTS RESERVED



World Authority in Advanced Technology for Magnetic, Vibratory and Metal Detection Applications

HEADQUARTERS: 2200 ASBURY ROAD, P.O. BOX 10608, ERIE, PA 16514-0608 U.S.A.

Telephone 814/835-6000 • 800/345-4946 • Fax 814/838-4960 • International Fax 814/833-3348

Web Site: <http://www.eriez.com>

e-mail: eriez@eriez.com

MANUFACTURING FACILITIES IN: AUSTRALIA • BRAZIL • CANADA • CHINA • INDIA • JAPAN • MEXICO • SOUTH AFRICA • UNITED KINGDOM • UNITED STATES